

Clarion®

Owner's manual & Installation manual
Mode d'emploi et manuel d'installation
Manual de instrucciones y de instalación

VRX935VD

AM/FM DVD VIDEO / VIDEO CD / CD / MP3
PLAYER / CD CHANGER CONTROLLER WITH 7"
LC DISPLAY

CONTRÔLEUR DE RADIO AM/FM/LECTEUR DVD
VIDÉO /CD VIDÉO/CD/MP3/CHANGEUR CD AVEC
AFFICHEUR À CRISTAUX LIQUIDES DE 7"
POUCES!

CONTROLADOR DE RADIO DE AM/FM,
REPRODUCTOR DE DISCOS DVD/VIDEODISCOS
CD/CD/MP3/CAMBIADOR DE DISCOS CD CON
VISUALIZADOR DE CRISTAL LÍQUIDO DE 7"

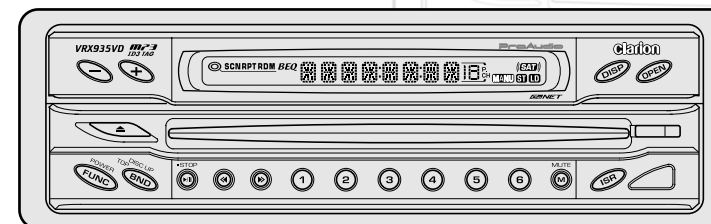
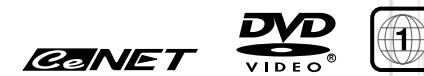

Clarion Co., Ltd.

All Rights Reserved. Copyright © 2003: Clarion Co., Ltd.
Printed in Japan/ Imprimé en Japon / Impreso en Japon

2003/1 (D-K)

QC-6810B
280-7897-01



Thank you for purchasing the Clarion **VRX935VD**.

- * This owner's manual is for the **VRX935VD**.
- * Please read this owner's manual in its entirety before operating this equipment.
- * After reading this manual, be sure to keep it in a handy place (e.g., glove compartment).
- * Check the contents of the enclosed warranty card and keep it carefully with this manual.
- * This manual includes the operating procedures of the CD changer, MD changer, DVD changer, TV tuner, SIRIUS, 5.1ch surround decoder. The CD changer, MD changer, TV tuner, 5.1ch surround decoder and DVD Changer have their own manuals, but no explanations for operating them are described.

Contents

1. FEATURES	2
2. PRECAUTIONS	3
3. CONTROLS	5
4. NOMENCLATURE	6
5. DISPLAY	8
6. OUTLINE OF BUTTON AND TOUCHKEY OPERATION	
WHEN THE DISPLAY IS OPEN	10
7. REMOTE CONTROL	14
8. DCP	17
9. CAUTIONS ON HANDLING	18
10. DVD VIDEO SYSTEM	19
11. OPERATIONS	21
Basic Operations	21
Radio Operations	25
DVD Video Player Operations	28
Visual Operations	42
CD/MD Changer Operations	45
DVD Changer Operations	49
TV Operations	49
SIRIUS Operations	52
Other Functions	55
5.1 ch Surround Decoder Operations	58
12. IN CASE OF DIFFICULTY	61
13. ERROR DISPLAYS	63
14. SPECIFICATIONS	64
<i>Installation and wire connection manual</i>	65

1. FEATURES

- Fully-Motorized 7" Widescreen LCD
- Touch Panel Control
- DVD Video/CD-DA/MP3/Video CD Play Capability
- 6-Channel, 4Volt RCA Line Level Output
- Built-in 53W × 4 Amplifier
- CeNET with Balanced Audio Line Transmission and Dynamic Noise Canceling
- Multi Angle, Multi Story, Slow Motion Capability
- ID3 Tag Capability
- CD TEXT Capable
- CD-R/CD-RW Compatible
- 5.1 Channel Decoder for DTS and Dolby Digital Capability
- Optical Digital Output



- Radio mode : **FM1 98.1MHz Pch 1**(band/frequency/preset No.)
- SIRIUS mode : **SR1 100ch Pch 1**(band/channel/preset No.)
- DVD changer mode: **D2 T02 C002 01:08:20**
(disc No./title No./chapter No./ playback time)
- DVD video mode : **T01 C003 00:08:20**(title No./chapter No./playback time)
- Video CD mode : **T01 00:01:18**(track No./playback time)
- MP-3 mode : **F001 T001 00:04:07**(folderNo./track No./playback time)
- CD mode : **TRACK 02 04 : 07**(track No./playback time)
- CD/MD changer mode: **D02 T02 00 : 45**(disc No./track No./playback time)
- TV mode : **TV1 28CH Pch 1**(band/channel/preset No.)
- VISUAL mode : **VISUAL 1** (band)



Mode name

MOTION/SPRITE
pattern display

Clock time

- **MANU** : Seek/Manual indication
- **ST** : Stereo indication
- **LD** : Loudness indication

When the 5.1ch surround decoder (DVH920) is connected, the program format of the digital input signal (for example, "3/2+LFE") is displayed.

- **BEQ** : Beat-EQ indication
- When the 5.1ch surround decoder (DVH920) is connected, the signal format of the digital input signal (for example, "Dolby D") is displayed.

- Radio/TV mode : **PROGRAM ▶ WEST COAST** (user title)
- SIRIUS mode : **CH.NAME ▶ CH801** (channel name)
: **TITLE ▶ WALK THIS WAY** (title)
: **ARTIST ▶ CH801** (artist)
: **CATEGORY ▶ ROCK** (category)
- CD changer mode : **USER TITLE ▶ SHINE** (user title)
- CD TEXT in CD changer mode
: **DISC TITLE ▶ SHINE** (disc title)
: **TRACK TITLE ▶ Time has come** (track title)
: **ARTIST ▶ Time has come** (artist)
- MD changer mode : **DISC TITLE ▶ SHINE** (disc title)
: **TRACK TITLE ▶ Time has come** (track title)

6. OUTLINE OF BUTTON AND TOUCHKEY OPERATION WHEN THE DISPLAY IS OPEN

*1



*3



*2



Note:

- The background of some screens in the following sections have been simplified to make it easier to see the keys in each procedure.

*1: The STANDARD screen indication in the radio mode

*2: Press an operation button to switch the STANDARD screen.

The operation button is [FUNC] button in the description of operation per mode.

*3: Touch the screen and the menu screen corresponding to the play mode is displayed.

*4: Touch an operation key to switch the menu screen.

The operation key is [FUNCTION] key in the description of operation per mode.

*5: Touch the [RTN] key to return to the previous screen.

*6: Touch the [↓] key to go to the next menu.

*7: Touch the [↑] key to return to the previous menu.

*8: This icon  is displayed to indicate that the button should be held down for 1 second or longer.

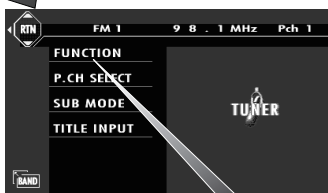

*4

FUNCTION

*5

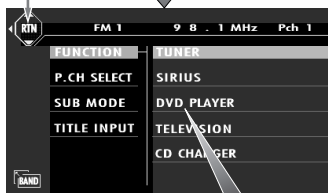

DVD PLAYER

RTN

ADJ
(ADJUST MODE menu)

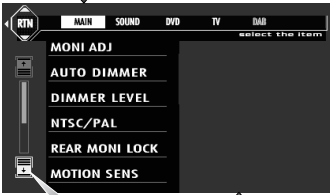

*6 ↓ *7 ↑

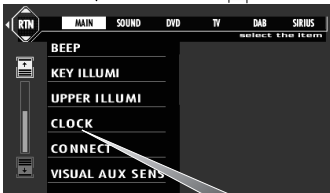

CLOCK

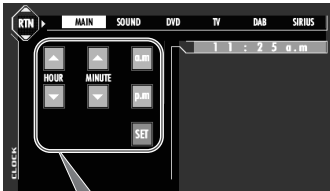

↑ ↓ a.m. p.m. SET
RTN

FUNC
*8
ADJ
(DVD SETUP menu)



STOP

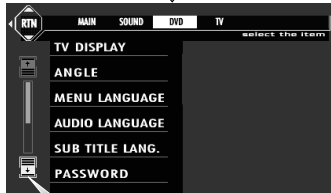

*6 ↓

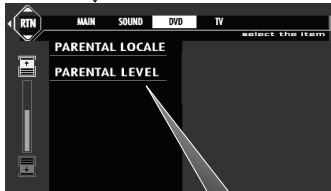

PARENTAL LEVEL

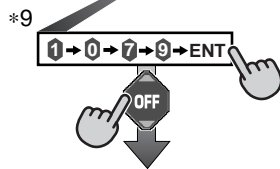
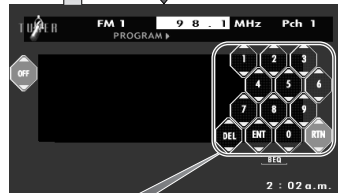
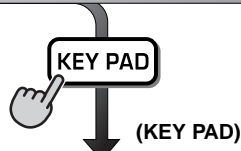
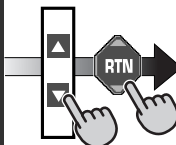
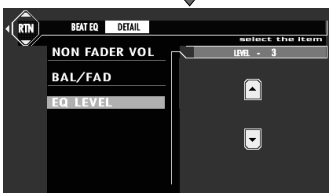
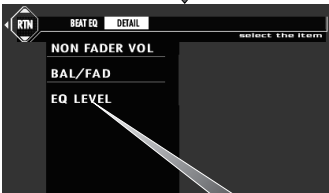
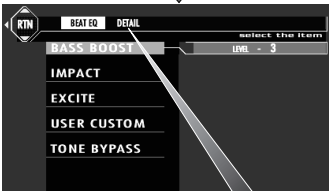
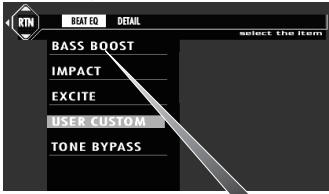

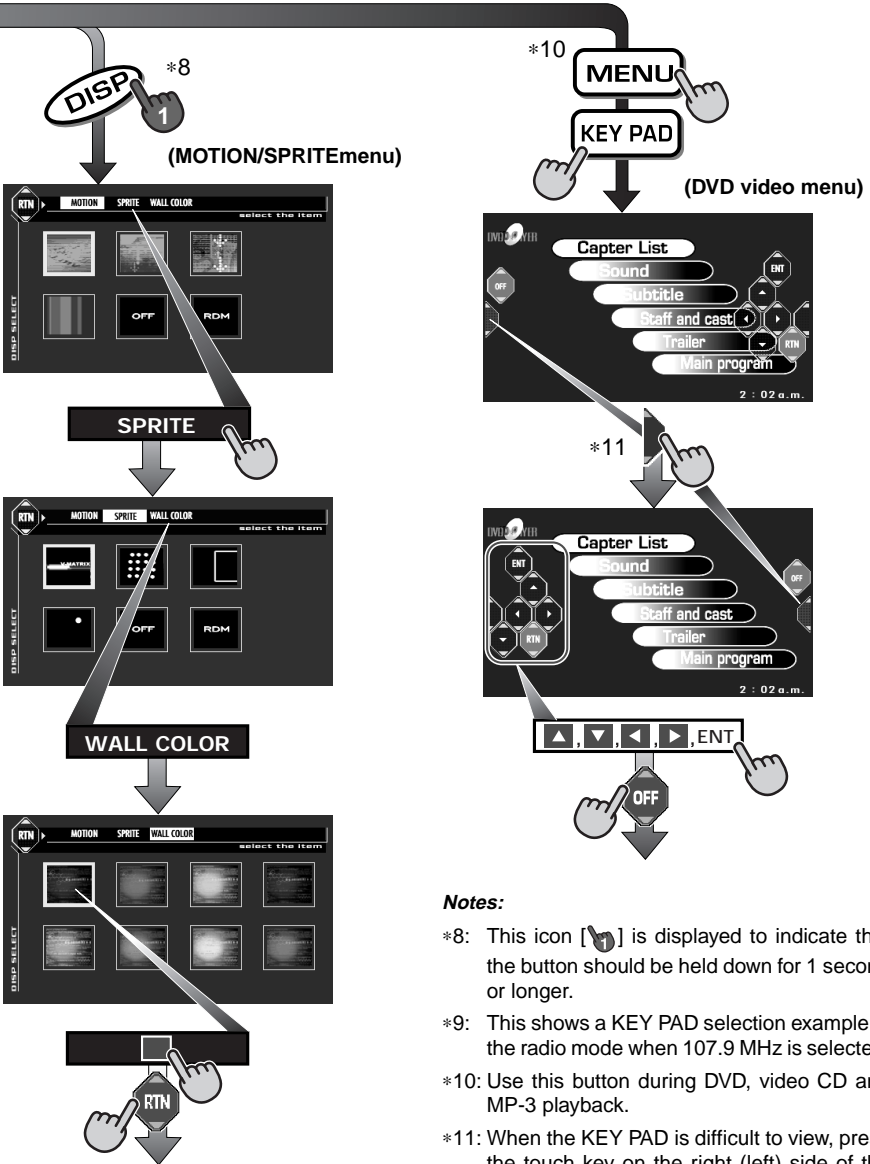

Notes:

- *8: This icon [DISP] is displayed to indicate that the button should be held down for 1 second or longer.
- *9: This shows a KEY PAD selection example in the radio mode when 107.9 MHz is selected.
- *10: Use this button during DVD, video CD and MP-3 playback.
- *11: When the KEY PAD is difficult to view, press the touch key on the right (left) side of the screen to move it to the other side of the screen.

7. REMOTE CONTROL

Remote control unit

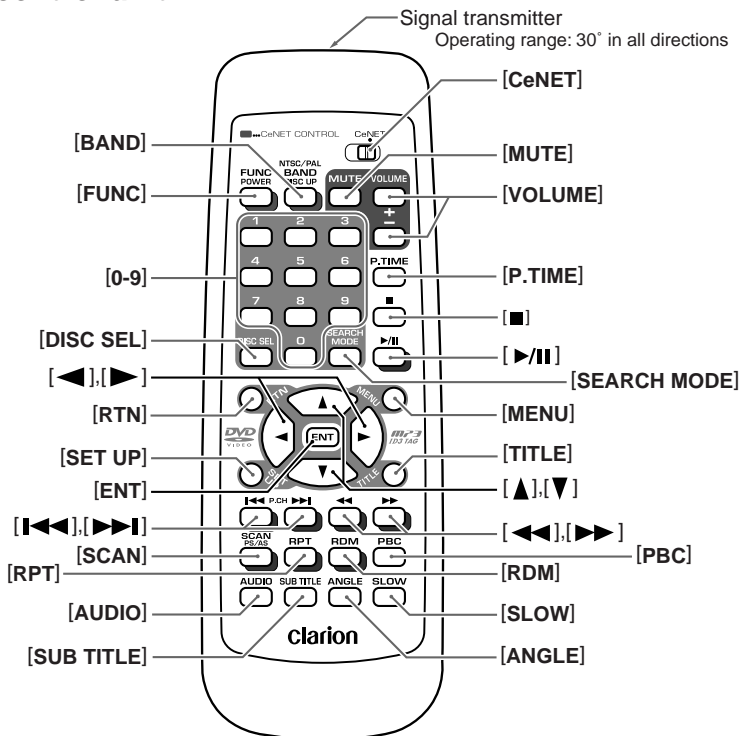

Inserting the Batteries

1. Turn the remote control unit over, then slide the rear cover in the direction of the arrow.
2. Insert the AA (SUM-3, IECR-6/1.5V) batteries that came with the remote control unit facing in the directions shown in the figure, then close the rear cover.

Notes:

Using batteries improperly can cause them to explode. Take note of the following points:

- When replacing batteries, replace both batteries with new ones.
- Do not short-circuit, disassemble or heat batteries.
- Do not dispose of batteries into fire or flames.
- Dispose of spent batteries properly.

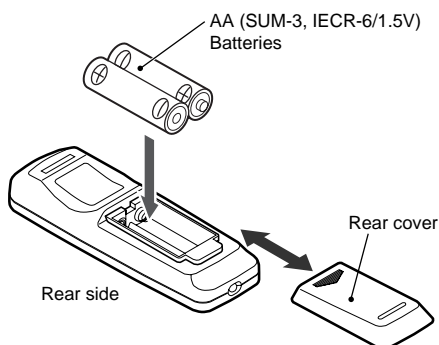

Functions of Remote Control Unit Buttons

● Shared modes

[FUNC] button

- Press and hold this button for 1 second or longer to turn on or off the power. Power on/off, switches among radio, TV, etc.

[VOLUME] button

- Increases and decreases volume.

[MUTE] button

- Turns mute on and off.

[CeNET] switch

- For operating this unit, switch this switch to the CeNET position.

● Radio/TV/SIRIUS mode

[BAND] button

- Switches reception band.

[0 - 9] button

- Use in the KEY PAD operation screen to set the radio frequency and TV/SIRIUS channels.

[DISC SEL] button

- Press to display the P.CH SELECT screen.

[SEARCH MODE] button

- Press to display the KEY PAD operation screen.

[ENT] button

- Press to confirm numerics entered in the KEY PAD operation screen.

[|◀◀], [▶▶|] buttons

- Press to select the next higher or lower preset channel in radio and TV/SIRIUS mode.

[◀◀], [▶▶] button

- Press to select the next higher or lower frequency in radio and channel in TV/SIRIUS mode.

[SCAN] button

- Press to perform preset scans in the radio, TV and SIRIUS modes.
- Hold down to perform the auto store operation in the radio and TV modes.

● DVD player mode

[BAND] button

- Press to return to the first chapter in DVD video mode.

- Press to return to the first track in CD/MP-3 mode or video CD mode with the PBC function turned off.

[P.TIME] button

- Press to turn on and off the playtime display in the DVD video and video CD mode.
- Press and hold this button for 1 second or longer to switch the playback status display contents.

[■] button

- Press to stop video playback in DVD video and video CD mode.

[▶/||] button

- Press to play or pause video and audio media.

[0 - 9] button

- Press to enter DVD video chapters in the KEY PAD screen.
- Press to set the track number of the Video CD with the PBC function turned off, CD track number or MP-3 track number in the KEY PAD screen.

[SEARCH MODE] button

- Press to display the KEY PAD operation screen.

[RTN] button

- Press to switch the screen display while the MENU screen is being displayed. However, it may occur that this button operation does not work on some discs.

[MENU] button

- Press to display menu stored on video disc.
- MP3: Returns the cursor to the default position and displays the files (track) select screen.

[SET UP] button

- Press to display the menu for setting audio features during DVD video playback.
- Press and hold this button for 1 second or longer to show the DVD SETUP menu.
 - * If you want to select a menu after the SETUP menu is displayed, touch the operation keys on the menu screen.

[TITLE] button

- Press to display the title screen on DVD video discs. Some discs do not display the title screen.

Functions of Remote Control Unit Buttons

[▲], [▼], [◀], [▶] button

- Press to select menus and other items during DVD video/MP-3 playback.

[ENT] button

- Press to confirm numerics entered in the KEY PAD operation screen.

[◀◀] [▶▶] buttons

- Press to select the next higher or lower chapter number in DVD video mode.
- Press to select the next higher or lower track numbers in CD/MP-3 mode or video CD mode with the PBC function turned off.

[◀◀] [▶▶] button

- Hold down to perform fast-forward and fast-backward.

[SCAN] button

- Press to perform chapter scans in DVD video mode and track scans in CD mode. Press to perform track scan and hold down to perform folder in MP-3 mode.

[RPT] button

- Press to perform chapter repeat in DVD video mode and track repeat in CD mode. In the MP-3 mode, press to perform track repeat and hold down to perform folder repeat.

[RDM] button

- Press to play tracks at random in CD mode. In the MP-3 mode, press to play tracks at random and hold down to play folders at random.

[PBC] button

- Press to turn on and off the PBC function in video CD mode.
If the button is pressed and held for 5 seconds or longer, the DVD video player parameter settings are returned to the factory default settings.

[AUDIO] button

- Press to switch on the AUDIO function in DVD video and video CD modes.

[SUB TITLE] button

- Press to display subtitles in DVD video mode.

[ANGLE] button

- Press to turn the ANGLE function on and off in DVD video mode. (This button is available only on multiple angles DVDs.)

[SLOW] button

- Press to perform slow playback in DVD video or video CD mode.

● CD/MD changer mode

[BAND] button

- Press to switch discs.

[DISC SEL] button

- Used to change the disc.

[▶/||] button

- Press to play and pause the media.

[0 - 9] buttons

- Press to enter track numbers in the KEY PAD screen.

[SEARCH MODE] button

- Press to display the KEY PAD operation screen.

[◀◀] [▶▶] buttons

- Press to select the next higher or lower playback track.

[◀◀] [▶▶] button

- Hold down to perform fast-forward and fast-backward.

[SCAN] button

- Press to perform track scan and hold down to perform disc scan.

[RPT] button

- Press to perform track repeat and hold down to perform disc repeat.

[RDM] button

- Press to play tracks at random and hold down to play folders at random.

● DVD changer mode

[BAND] button

- Press to switch discs.

[DISC SEL] button

- Used to change the disc.

* **Other button operations in this mode are the same as those in DVD player mode.**

8. DCP

The control panel can be detached to prevent theft. When detaching the control panel, store it in the DCP (DETACHABLE CONTROL PANEL) case to prevent scratches.

We recommend taking the DCP with you when leaving the car.

Removing the DCP

1. Turn the power off.
2. Slide the [RELEASE] lever leftward to release the DCP/Operation Panel.

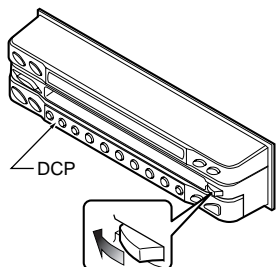

3. Pull the DCP toward you and remove it.

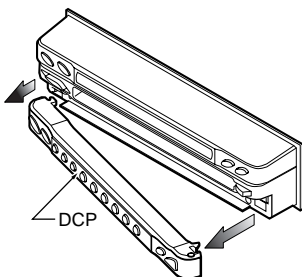

Attaching the DCP

1. Insert the DCP so that the (A) section on the left side of the DCP catches on the hook (B) on the unit.

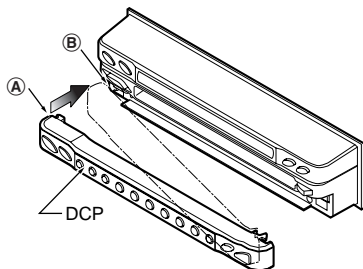

2. Press the right side of the DCP carefully to fit it in place.

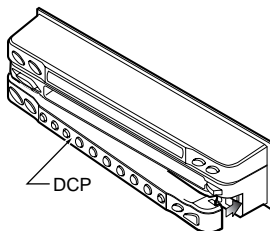

3. Press the [FUNC] button to turn on the power.

CAUTION

- The DCP can easily be damaged by shocks. After removing it, be careful not to drop it or subject it to strong shocks.
- If the Operation Panel is kept open, the DCP may drop due to vibration of the car. This results in damage to the DCP. So close the Operation Panel or remove the DCP to store into the case.
- The DCP is an extremely important part. Be careful not to damage it by pressing on it with fingernails, screwdrivers, etc.
- In case the Control Panel is kept open
When you detach the DCP, the panel is to be stored automatically after a warning sound.
When you attach the DCP, the panel is to come out to its original position after a warning sound.

Note:

- If the DCP is dirty, wipe off the dirt with a soft, dry cloth only.

9. CAUTIONS ON HANDLING

LCD panel/Generalities

For a longer service life, be sure to read the following cautions.

- Be sure to store the LCD panel inside the main unit when parking the car outdoors for long period of time. The LCD panel will operate properly in a temperature range of 0 to 60°C.
- Don't allow any liquids on the set from drinks, umbrellas etc. Doing so may damage the internal circuitry.
- Do not disassemble or modify the set in any way. Doing so may result in damage.
- Do not draw the LCD panel out and use it as a tray. Also, subjecting the LCD panel to shocks may result in breakage, deformation or other damage.
- Do not let cigarettes burn the display. Doing so may damage or deform the cabinet.
- If a problem should occur, have the set inspected at your store of purchase.
- Do not insert objects or poke in the space between the LCD panel and the main unit when the panel is tilted.
- Do not place anything on the display when the panel is tilted.
- The remote controller may not work if the remote control sensor is exposed to direct sunlight.
- In extremely cold weather, the display movement may slow down and the display may darken, but this is not a malfunction. The display will work normally when the temperature increases.
- Small black and shiny spots inside the LCD panel are normal for LCD products.
- The LCD panel may stop temporarily when it opens or closes, when the engine stops or when it is cold.
- The touchkeys on the display operate when slightly touched. Do not press the touchkey screen with much force.
- Do not push the case surrounding the touchkey panel with much force. This may cause malfunctioning of the touchkeys.

Cleaning

• **Cleaning the cabinet**

Use a soft, dry cloth and gently wipe off the dirt. For tough dirt, apply some neutral detergent diluted in water to a soft cloth, wipe off the dirt gently, then wipe again with a dry cloth.

Do not use benzene, thinner, car cleaner, etc., as these substances may damage the cabinet or cause the paint to peel. Also, leaving rubber or plastic products in contact with the cabinet for long periods of time may cause stains.

• **Cleaning the LCD panel**

The LCD panel tends to collect dust, so wipe it off occasionally with a soft cloth. The surface is easily scratched, so do not rub it with hard objects.

10. DVD VIDEO SYSTEM

DVD video is a high-quality digital video source that provides crisp and clear images. One 12 cm disc contains either one film or four hours of music.

DVD Video Features

This unit provides the following functions in addition to the high image quality and sound quality of DVD video.

Notes:

- The functions described in the section, "Features", for example, the recorded language, subtitles, angles, etc. differ with the DVD video disc. Refer to the instructions provided with the DVD video.
- Some disc functions may operate differently than described in this manual.

Multi-sound function

DVD video can store up to 8 languages for one film; select the language of your preference.

- The languages stored on the disc are indicated by the icon shown below.



Multi-angle function

A DVD video that is filmed from multiple angles allows you to select the angle of choice.

- The number of recorded angles are indicated by the icon shown below.

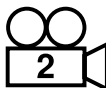

Subpicture (subtitles) function

A DVD video can record subtitles for up to 32 languages and you can select the language of the subtitles you wish to see.

- The number of recorded subtitle languages are indicated by the icon shown below.



Multi-story function

When a DVD video contains more than one story for a film, you can select the story you wish to enjoy. The operation procedures vary with the disc; observe the instructions for selecting a story provided during playback.

Dolby digital

Dolby digital enables up to 5.1 independent multi-channel audio reproduction, the same type of surround system that is also used in movie theaters.

DTS

DTS (Digital Theater System) is a digital sound compression technique developed by Digital Theater Systems, Inc.

This low sound compression format delivers a large amount of data and makes it possible to reproduce a high quality sound.

Menu screens

Menus can be called up during DVD video playback to perform menu setting.

- Example showing menu display

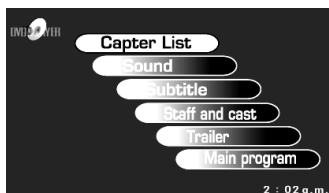

Discs

Playable discs

This DVD video player can play the following discs.

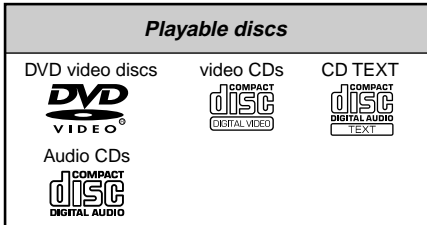

About CD Extra discs

A CD Extra disc is a disc in which a total of two sessions have been recorded. The first session is Audio session and the second session Data session.

Your personally-created CDs with more than 2 data sessions recorded cannot be played on this DVD video player.

Discs that cannot be played back

This DVD video player cannot play back DVD-R, DVD-RAM, DVD-ROM, CD-ROM, Photo CDs.

- Some CDs recorded in CD-R/CD-RW mode may not be usable. (Cause: disc characteristics, cracks, dust/dirt, dust/dirt on player's lens, etc.)

Note on region numbers

The DVD video system assigns a region number to DVD video players and DVD discs by sales area. DVD video players sold in the United States can play back DVD discs with the region number "ALL", "1" or any combination of numbers that also incorporate a "1".

The DVD video region number is marked on the disc jacket as shown below.



TV color system

This DVD player plays NTSC discs and PAL discs only and cannot be used for playback of SECAM discs.

About MP3 playback

This unit can play back CD-R/CD-RW discs on which MP3 music data have been recorded.

For a detailed information, see the page entitled "Listening to an MP3".

About the registered marks etc.

- This product incorporates copyright protection technology that is protected by method claims of certain U.S. patents and other intellectual property rights owned by Macrovision Corporation and other rights owners. Use of this copyright protection technology must be authorized by Macrovision Corporation, and is intended for home and other limited viewing uses only unless otherwise authorized by Macrovision Corporation. Reverse engineering or disassembly is prohibited.
- Manufactured under license from Dolby Laboratories.
"Dolby" and the double-D symbol are trademarks of Dolby Laboratories.
- "DTS" is a registered trademark of Digital Theater Systems, Inc.

11. OPERATIONS

Basic Operations

Note: Be sure to read this chapter referring to the front diagrams of chapter "3. CONTROLS" on page 5 (unfold).

⚠ CAUTION

When the unit is turned on, starting and stopping the engine with its volume raised to the maximum level may harm your hearings. Be careful about adjusting the volume.

Note:

- Use this unit after starting the engine.



ACC or engine
ON position

Turning on and off the power

Note:

- Be careful about using this unit for a long time without running the engine. If you drain the car's battery too far, you may not be able to start the engine and this can reduce the service life of the battery.

1. Press the [FUNC] button.
2. The illumination and display on the unit light up. The unit automatically remembers its last operation mode and will automatically switch to display that mode.
3. Press and hold the [FUNC] button for 1 second or longer to turn off the power for the unit.

Note:

- About the "SYSTEM CHECK"

The confirmation of connected equipment must be performed for this unit only when the wiring connection is complete and power is turned on to the unit first. When the power is supplied, "PUSH PWR" appear in the display. Press the [FUNC] button, the system check starts inside the unit. When "COMPLETE" and "PUSH PWR" appear alternately, press once again the [FUNC] button.

Selecting a mode

1. Press the [FUNC] button to change the mode of operation.
2. Each time you press the [FUNC] button, the mode of operation changes in the following order:

Radio mode → SIRIUS mode → DVD mode
→ CD changer mode → MD changer mode
→ DVD changer mode → TV mode → VI-SUAL mode → Radio mode...

- * External equipment not connected with CeNET is not selected.

Adjusting the volume

1. Operate the [VOL] button in the direction of the + (up) or – (down) to adjust the volume;
- + : Increases the volume.
 - : Decreases the volume.
- * The volume level indicated in the display is in a range from 0 (minimum) to 33 (maximum).

⚠ CAUTION

While driving, keep the volume at a level at which external sounds can be heard.

Switching the display

When the panel is closed:

1. Press the [DISP] button to select the desired display.

Each time you press the [DISP] button, the display switches in the following order:

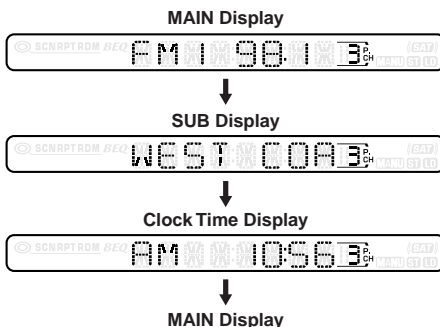

Notes:

- Once selected, the preferred display becomes the default display. When a function adjustment such as volume is made, the display momentarily switches to that function's display, then returns back to the preferred display several seconds after the adjustment.
- If a title has been input, it is shown in the SUB display. If no title has been input, "NO TITLE" appears in the display. To input a title, refer to the subsection "Entering titles" in "Other Functions" section.
- For CD, MD and TV, some special characters of the title will not be displayed on the Information Panel of the DCP. In this case, those characters will only be left blank.

Basic Operations

Opening and turning the display

⚠ WARNING

- To prevent the battery from going dead, operate this unit with the engine running, if possible.
- When the liquid crystal panel is operating, be careful not to get your hand or finger caught between the panel and main unit or the instrument panel of the car.

Standing up the liquid crystal panel

1. Press the [OPEN] button and the liquid crystal panel comes out and stand up automatically.

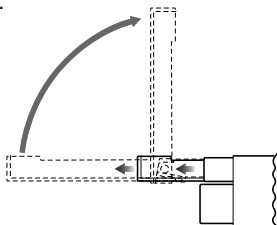

- * While the liquid crystal panel is opening or closing, the LED of the [FUNC] button blinks.

NOTE:

- If the liquid crystal panel stops in the middle of its operation, press the [OPEN] button to house the panel and press the button again to stand it up. The unit enters the same display mode as the display was turned off the last time.

Adjusting the angle, etc. of the liquid crystal panel

The angle of the liquid crystal panel or protruding amount of the panel from the mounting surface can be adjusted depending on the mounting angle of the unit or light coming into the car.

● To adjust the angle

1. Every time the [TILT] button is pressed, the liquid crystal panel tilts forward or backward at up to about 20 degrees. The adjusted angle is stored in memory.

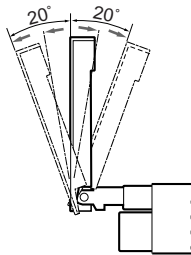

NOTE:

- Do not move the liquid crystal panel by hand.

● To adjust the slide position

1. Press and hold the [TILT] button and release when a beep is heard.

The liquid crystal panel slides forward or backward. The adjusted slide position is stored in memory.

- * There are 3 adjustable positions available on this panel.

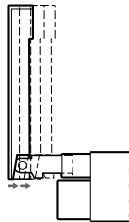

Housing the liquid crystal panel

1. Press the [OPEN] button and the liquid crystal panel is housed automatically.

NOTE:

- When leaving this unit unused for a long period of time or leaving your car, be sure to house the liquid crystal panel into the main unit.

Turning the liquid crystal panel horizontal (Air conditioner operation mode)

When the way the liquid crystal panel is mounted hinders the operation of the air conditioner, the position of the panel can be turned horizontal temporarily.

1. Press and hold the **[OPEN]** button when the liquid crystal panel is upright, and release the button when a beep is heard.
2. The liquid crystal panel turns horizontal.
 - * Press the **[OPEN]** button again when the liquid crystal panel is in the horizontal position, and the panel returns to the original position.
 - * Even if the button is not operated for about 10 seconds, the panel returns to the original position with a warning sound.

Turning on and off the monitor

1. Pressing and holding the **[M.L]** button for 1 second or longer turns the monitor off. To return to the monitor on, press the **[M.L]** button once again.
 - * When a button is pressed or during security monitoring, the monitor-off mode is canceled.

Mute

1. Each time you press the **[MUTE]** button, mute is turned on and off. "MUTE" appears when mute is turned on.

Setting the Beat EQ

- This function is enabled only when the panel is open.

This unit comes with 3 types of sound tone effect stored in memory. Select the one you prefer.

- * The factory default setting is "USER CUSTOM".
1. Press the **[A-M]** button to change into the AUDIO MODE menu.
 2. When the AUDIO MODE menu is displayed, touch the key for the desirable type to select it.
 - **BASS BOOST** : bass emphasized
 - **IMPACT** : bass and treble emphasized
 - **EXCITE** : bass and treble emphasized mid de-emphasized
 - **USER CUSTOM** : user custom
 - **TONE BYPASS** : no sound effect (Beat EQ off)

3. When the setting is finished, touch the **[RTN]** key or press the **[A-M]** button to return to the previous mode.

When the Beat EQ (BASS BOOST, IMPACT, EXCITE, USER CUSTOM) is set, "B.EQ" appears in the display.

Note:

- When the separately-sold Multiple Channel Processor (DVH920) is used, the bass and treble tone adjustments cannot be made. To adjust the tone, refer to the section "Multiple Channel Processor Operations".

Adjusting the non fader output volume

You can adjust the volume output from the unit's non fader output terminal.

1. Press the **[A-M]** button, then touch the **[DETAIL]** key.
2. Touch the **[NON-FAD VOL]** key.
3. Touch the **[▲]** or **[▼]** key to adjust to desirable level.
 - * The factory default setting is "0". (Setting range: -6 to 6)
4. When the adjustment is complete, touch the **[RTN]** or press the **[A-M]** button to return to the previous mode.

Adjusting the bass

The bass gain, bass frequency (center frequency) and bass Q can be adjusted as follows.

1. Press the **[A-M]** button, then touch the **[USER CUSTOM]** key.
2. Touch the **[DETAIL]** key, then touch the **[BASS]** key.
3. When the bass type selection screen is displayed, touch the key for the desirable type to select it.
4. Touch the **[▲]** or **[▼]** key to adjust to desirable level.
 - GAIN : -6 to 8 (The factory default setting is "0")
 - FREQ. : 50Hz/80Hz/120Hz (The factory default setting is "50")
 - Q : 1/1.25/1.5/2 (The factory default setting is "1")
5. When the adjustment is complete, touch the **[RTN]** key several times or press the **[A-M]** button to return to the previous mode.

Basic Operations

Adjusting the MID

The MID gain, MID frequency (center frequency) and MID Q can be adjusted as follows.

1. Press the **[A-M]** button, then touch the **[USER CUSTOM]** key.
2. Touch the **[DETAIL]** key, then touch the **[MID]** key.
3. When the bass type selection screen is displayed, touch the key for the desirable type to select it.
4. Touch the **[▲]** or **[▼]** key to adjust to desirable level.

GAIN : -6 to 6 (The factory default setting is "0")

FREQ. : 700Hz/1kHz/2kHz (The factory default setting is "1k")

Q : 1.5/2 (The factory default setting is "2")
5. When the adjustment is complete, touch the **[RTN]** key several times or press the **[A-M]** button to return to the previous mode.

Adjusting the TREBLE

The treble gain and treble frequency (center frequency) can be adjusted as follows.

1. Press the **[A-M]** button, then touch the **[USER CUSTOM]** key.
2. Touch the **[DETAIL]** key, then touch the **[TREBLE]** key.
3. When the bass type selection screen is displayed, touch the key for the desirable type to select it.
4. Touch the **[▲]** or **[▼]** key to adjust to desirable level.

GAIN : -6 to 6 (The factory default setting is "0")

FREQ. : 8kHz/12kHz (The Factory default setting is "12K")
5. When the adjustment is complete, touch the **[RTN]** key several times or press the **[A-M]** button to return to the previous mode.

Adjusting the balance/fader

1. Press the **[A-M]** button, then touch the **[DETAIL]** key.
2. Touch the **[BAL/FAD]** key.
3. Touch the **[▲]** or **[▼]** key to adjust to the fader level.

- * The factory default setting is "0". (Adjustment range: front 13 to rear 13)
- [▲]** key : Emphasized the sound from the front speakers.
- [▼]** key : Emphasized the sound from the rear speakers.
- 4. Touch the **[◀]** or **[▶]** key to adjust to the balance level.
 - * The factory default setting is "0". (Adjustment range: left 12 to right 12)
 - [◀]** key : Emphasized the sound from the left speakers.
 - [▶]** key : Emphasized the sound from the right speakers.
- 5. When the adjustment is complete, touch the **[RTN]** key several times or press the **[A-M]** button to return to the previous mode.

Adjusting the Beat EQ

1. Press the **[A-M]** button and select "**BASS BOOST** or **IMPACT** or **EXCITE**".
2. Touch the **[DETAIL]** or **[LEVEL]** key to display the level adjustment screen.
3. Touch the **[▲]** or **[▼]** key to adjust to desirable level.
 - * When **BASS BOOST** is selected, you can adjust the bass in the range of -3 to 3.
 - * When **IMPACT** and **EXCITE** is selected, you can adjust the bass and treble in the range of -3 to 3.
4. When the adjustment is complete, touch the **[RTN]** key several times or press the **[A-M]** button to return to the previous mode.

Turning on/off the loudness

The loudness effect emphasizes the bass to create a natural sound tone. When you are listening to music at a low volume, it is recommended to use the loudness effect.

1. Press and hold the **[A-M]** button for 1 second or longer to turn on the loudness effect. When the loudness effect is turned on, "**LD**" lights in the display.
2. Press and hold the **[A-M]** button for 1 second or longer to turn off the loudness effect. "**LD**" goes off in the display.

Changing the setting of the display background

⚠ WARNING

Perform the setting of this function the car is stopped with the parking break applied.

- Press the **[DISP]** button for 1 second or longer to show the background setup menu.
 - * This menu can be displayed only in the radio, DVD (CD, MP3) or CD/MD changer mode and only while your car is being driven.
- Touch the setting key to show the setup display.
 - **To set up the motion pattern**
 - 2-1. Touch the **[MOTION]** key to set a desired motion pattern.
 - 2-2. Touch a desired MOTION PATTERN.
 - **To set up the sprite pattern**
 - 2-1. Touch the **[SPRITE]** key to set a desired sprite pattern.
 - 2-2. Touch a desired SPRITE PATTERN.
 - **To set up the wall color**
 - 2-1. Touch the **[WALL COLOR]** key to set a desired wall color.
 - 2-2. Touch a desired WALL COLOR.
- Press the **[DISP]** button again or touch the **[RTN]** key to return to the STANDARD screen.

Radio Operations

FM reception

For enhanced FM performance the **MAGTUNE+**® tuner includes signal actuated stereo control, Enhanced Multi AGC, Impulse noise reduction circuits and Multipath noise reduction circuits.

Changing the reception area

This unit is initially set to USA frequency intervals of 10kHz for AM and 200kHz for FM. When using it outside the USA, the frequency reception range can be switched to the intervals of 9 kHz for AM and 50 kHz for FM.

● Setting the reception area

- While pressing **[DISP]** button, each time you press and hold the number "6" of the **[DIRECT]** buttons for 2 seconds or longer, the reception area switches from inside the USA to outside the USA or from outside the USA to inside the USA.
 - * Any station preset memories are lost when the reception area is changed.

Listening to the radio

- Press the **[FUNC]** button and select the RADIO mode. The frequency is displayed.
- Press the **[BAND]** button and select the radio band. Each time the button is pressed, the radio reception band changes in the following order:
FM1 → FM2 → FM3 → AM → FM1...
- Press the **[◀▶]** or **[▶▶]** button to tune in the desired station.
 - * When the panel is open, the same operation is also available by using the **[◀▶]** or **[▶▶]** button in the panel.

Radio Operations

Seek tuning

1. Press the **[BAND]** button and select the desired band. (FM or AM)
2. Tune in to a station.
 - * If **"MANU"** is lit in the display press and hold the **[BAND]** button for 1 second or longer. **"MANU"** in the display goes off and seek tuning is now available.
3. Press the **[◀◀]** or **[▶▶]** button to automatically seek a station.

When the **[▶▶]** button is pressed, the station is sought in the direction of higher frequencies; when the **[◀◀]** button is pressed, the station is sought in the direction of lower frequencies.

* When the panel is open, the same operation is also available by using the **[◀◀]** and **[▶▶]** button in the panel.

Selecting stations with the KEY PAD

* This function displays the KEY PAD on the screen enabling you to tune in through auto store, preset scan or by entering a frequency.

Press the **[KEY PAD]** button to display the KEY PAD.

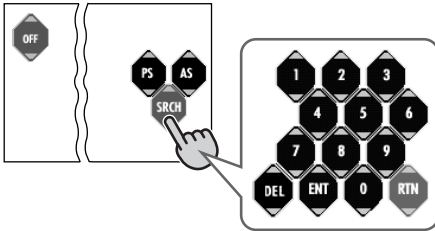

● Tuning in by selecting a frequency

1. Touch the **[SRCH]** key to switch the KEY PAD.
2. Touch the **[0]–[9]** key corresponding with the frequency you desired. When you touch the wrong number (**[0]–[9]** key), you can cancel that to touch the **[DEL]** key.
3. Touch the **[ENT]** key. The radio station you required would be tuned.

● To use auto store,

touch the **[AS]** key for about 2 seconds.

● To perform a preset scan,

touch the **[PS]** key.

● To cancel the KEY PAD display,

press the **[KEY PAD]** button or touch the **[OFF]** key.

Manual tuning

There are 2 ways available: Quick tuning and step tuning.

When you are in the step tuning mode, the frequency changes one step at a time. In quick tuning mode, you can quickly tune the desired frequency.

1. Press the **[BAND]** button and select the desired band. (FM or AM)
 - * If **"MANU"** is not lit in the display, press and hold the **[BAND]** button for 1 second or longer. **"MANU"** appears in the display and manual tuning is now available.
2. Tune into a station.

● Quick tuning:

Press and hold the **[◀◀]** or **[▶▶]** button for 1 second or longer to tune in a station.

● Step tuning:

Press the **[◀◀]** or **[▶▶]** button to manually tune in a station.

Recalling a preset station

A total of 24 preset positions (6-FM1, 6-FM2, 6-FM3, 6-AM) exists to store individual radio stations in memory. Pressing the corresponding **[DIRECT]** button recalls the stored radio frequency automatically.

There are 2 ways available to recall the preset station.

● Using the [DIRECT] button.

1. Press the **[BAND]** button and select the desired band. (FM or AM)
2. Press the corresponding **[DIRECT]** button to recall the stored station.
 - * Press and hold one of the **[DIRECT]** buttons for 2 seconds or longer to store that station into preset memory.

● Using the [DIRECT] key.

1. Press the **[LIST]** button or touch the screen when the **STANDARD** screen is displayed, then touch the **[P.CH SELECT]** key.
2. Touch the corresponding **[DIRECT]** key to recall the stored station.
 - * You can select the desired band to touch the **[BAND]** key.
3. Touch the **[RTN]** key or press the **[LIST]** button to return to the previous mode.

Manual memory

1. Press the **[BAND]** button and select the desired band. (FM or AM)
2. Select the desired station with seek tuning, manual tuning, or preset tuning.
3. Press and hold one of the **[DIRECT]** buttons for 2 seconds or longer to store the current station into preset memory.

Auto store

Auto store is a function for storing up to 6 stations that are automatically tuned in sequentially. If 6 receivable stations cannot be received, a previously stored station remains unoverwritten at the memory position.

1. Press the **[BAND]** button and select the desired band. (FM or AM)
2. Touch the screen switching touchkey when the STANDARD screen is showing or press the **[LIST]** button, the MENU screen appears.
3. Touch the **[SUB MODE]** key in the MENU screen and the **[AUTO STORE]** key appears in the display.
4. Touch and hold the **[AUTO STORE]** key for 2 seconds or longer.

The stations with good reception are stored automatically to the preset channels.

Preset scan

Preset scan receives the stations stored in preset memory in order. This function is useful when searching for desired station in memory.

1. Touch the screen switching touchkey when the STANDARD screen is showing or press the **[LIST]** button, the STANDARD screen appears.
2. Touch the **[SUB MODE]** key in the MENU screen and the **[PRESET SCAN]** key appears in the display.
3. Touch the **[PRESET SCAN]** key to start preset scan. The unit starts scanning each station for 7 seconds sequentially.
4. When the desired station is turned in, touch the **[PRESET SCAN]** key again to continue receiving that station.

Instant station recall (ISR)

Instant station recall is a special radio preset that instantly accesses a favorite radio station at a touch of a button. The ISR function even operates with the unit in other modes.

●ISR memory

1. Select the station that you wish to store in ISR memory.
2. Press and hold **[ISR]** button for 2 seconds or longer.

●Recalling a station with ISR

1. In any mode, press **[ISR]** button to turn on the radio function and tune the selected radio station. "ISR" appears in the display. Press **[ISR]** button again to return to the previous mode.

DVD Video Player Operations

Changing DVD system settings

Notes:

- If the **SETUP** operation is performed in the middle of video CD/DVD video play, the disc plays from the beginning.
- Various settings of the **SETUP** menu cannot be made with the remote control unit.

Selecting the DVD SETUP menu

1. Press and hold the **[ADJ]** button for 1 second or longer. DVD SETUP stand-by screen is displayed.
2. Press the **[STOP]** key to display the DVD SETUP menu.

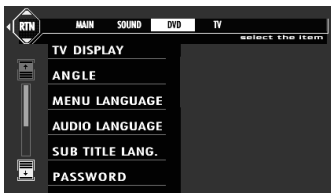

3. Touch the **[↓]** key. Touch the **[↑]** key to return to the previous menu.

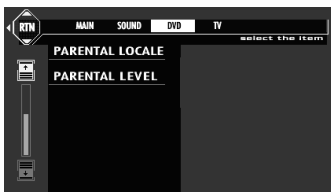

4. Touch the **[RTN]** key to return the previous mode.

Setting up the screen size

Set up the screen size according to the rear view monitor which is connected to this unit.

1. Following the steps 1 to 2 in “**Selecting the DVD SETUP menu**”, touch the **[TV DISPLAY]** key.
2. Touch the **[N PS]**, **[N LB]** or **[WIDE]** key to select a desired size to set it.

* The factory default setting is “**N PS**”.

The color of the selected item changes.

● When watching through a conventional type of the rear view monitor (4:3)

- **N PS** : The leftmost and rightmost areas of the screen are cut off.

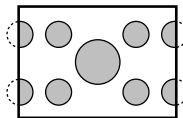

This function allows displaying the important part of image fully on the screen. In some cases, image is displayed while being panned (scrolled).

- **N LB** : A black zone is created in the top and bottom areas of the screen.

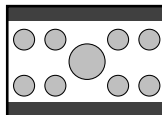

This method displays Cinema Scope and Vista Vision images without cutting them off by creating a black zone on the top and bottom gaps.

● When watching through a wide type of the rear view monitor (16:9)

- **WIDE** :

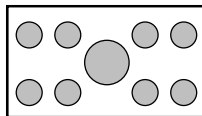

3. Touch the **[RTN]** key to return previous mode.

Setting up the angle mark display

You can set up so that the angle mark appears on scenes where the angles can be switched.

1. Following the steps 1 to 2 in “**Selecting the DVD SETUP menu**”, touch the **[ANGLE]** key.
2. Touch the **[ON]** or **[OFF]** key to select “**ON**” or “**OFF**”.

* The factory default setting is “**OFF**”.

3. Touch the **[RTN]** key to return previous mode.

Setting up the disc menu language.

1. Following the steps 1 to 2 in “**Selecting the DVD SETUP menu**”, touch the **[MENU LANGUAGE]** key.

- Touch the key to select a desired language to set it.
* The factory default setting is "ENGLISH".
- Touch the [RTN] key to return previous mode.

Setting up the audio language

- Following the steps 1 to 2 in "Selecting the DVD SETUP menu", touch the [AUDIO LANGUAGE] key.
- Touch the key to select a desired language to set it.
* The factory default setting is "ENGLISH".
- Touch the [RTN] key to return previous mode.

Setting up the subtitle language

- Following the steps 1 to 2 in "Selecting the DVD SETUP menu", touch the [SUB TITLE LANG.] key.
- Touch the key to select a desired language to set it.
* The factory default setting is "OFF".
- Touch the [RTN] key to return previous mode.

Setting up the password for setting up of the parental level

- Following the steps 1 to 2 in "Selecting the DVD SETUP menu", touch the [PASSWORD] (password) key.
- Touch the ten-key(0 to 9) to input a 4-digit password.
* The factory default setting is "0000".
 - Input an old password, and touch the [ENT] key.
 - Input a new password, and touch the [ENT] key.
- Touch the [RTN] key to return previous mode.

Note:

When a disc with view limited is played
When a disc with view limited is played, the input screen requiring you to input the password may appear. When this happens, enter the correct password, otherwise play does not start.

Setting up the country code

Set up the country number for setting up of the parental level.

- Following the steps 1 to 3 in "Selecting the DVD SETUP menu", touch the [PARENTAL LOCALE] key.
- Touch the ten-key(0 to 9) to input a 4-digit country code.
* The factory default setting is "8583"(U.S.A).

Country	Input code
CANADA	6765
UNITED STATES	8583
AMERICAN SAMOA	6583
BERMUDA	6677
PUERTO RICO	8082
ST. PIERRE AND MIQUELON	8077
VIRGIN ISLANDS (U.S)	8673

- Touch the [ENT] key.
- Touch the [RTN] key to return previous mode.

Setting up the parental level

You can change the level of parental lock (audio-visual restriction).

This function allows cutting scenes that are unfavorable for children or replacing them automatically with other scenes prepared in advance. For example, by replacing scenes of radical violence or portrayals of sex with safe scenes, you can make a trouble-free story as if it were so from the beginning.

- Following the steps 1 to 3 in "Selecting the DVD SETUP menu", touch the [PARENTAL LEVEL] key.
- When you touch the [▲] or [▼] key, PASSWORD input screen is displayed.
- Touch the ten-key(0 to 9) to input a 4-digit password, and touch the [ENT] key.
* The factory default setting of the password is "0000".
- Touch the [▲] or [▼] key to select level 1 to 8, or 0 (no parental).
* The factory default setting is "8".

DVD Video Player Operations

The relationship between DVD video category codes and parental level are shown in the table below. Use this table when setting the parental level.

LEVEL7	NC-17 (NO ONE 17 AND UNDER ADMITTED)
LEVEL6	R (RESTRICTED)
LEVEL4	PG-13 (PARENTS STRONGLY CAUTIONED)
LEVEL3	PG (PARENTAL GUIDANCE SUGGESTED)
LEVEL1	G (GENERAL AUDIENCES)

- The contents that the parental level restricts varies with the country code.

Basic Operations

Loading a disc

Insert a disc into the centre of the insertion slot with the label side facing up. The disc plays automatically after loading.

Notes:

- *Never insert foreign objects into the disc insertion slot.*
- *If the disc is not inserted easily, there may be another disc in the mechanism or the unit may require service.*

Loading 8 cm discs

- * No adapter is required to play an 8 cm disc.
- * Insert the 8 cm disc into the centre of the insertion slot.

⚠ CAUTION

With the screen open, a driver may not see the disc insertion slot. For your safety, insert a disc with the screen closed.

Watching/Listening to a disc already inserted

1. Press the [FUNC] button to select the DVD mode. Play starts automatically. If no disc is loaded in the unit, "NO DISC" appears in the display.

⚠ WARNING

- **Videos may be played back with particularly loud sound. Increase the volume gradually from the minimum after the video images are displayed.**
- **For your safety, the driver should not watch the video or operate the controls while driving. Please note that watching and operating the video while driving are prohibited by law in some countries.**

Notes:

- *For your safety, the VRX935VD has a safety function which turns off the picture when the car is moving, so only the audio can be heard. The picture can only be watched when the car is stopped and the parking break is applied.*

Pausing play

1. Press the [▶/||] button to pause play. "PAUSE" appears in the display.
2. To resume disc play, press the [▶/||] button again.

Ejecting a disc

1. Press the [▲] button a disc ejects. "EJECT" appears in the display.

* If a disc (12 cm) is left in the ejected position for 15 seconds, the disc is automatically reloaded. (Auto reload)

* 8 cm discs are not auto reloaded. Be sure to remove it when ejected.

Note:

• If you force a disc into before auto reloading, this can damage the disc.

Show the menu screen

1. Touch the screen to show the menu screen while the main screen is being shown.

* To return to the main screen from the menu screen, touch the [RTN] key.

KEY PAD operation

1. Press the [KEY PAD] button.

Each time the button is pressed, the KEY PAD changes as follows.

● In DVD video mode

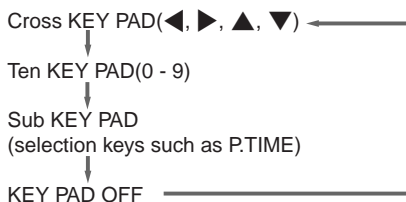

● In video CD mode

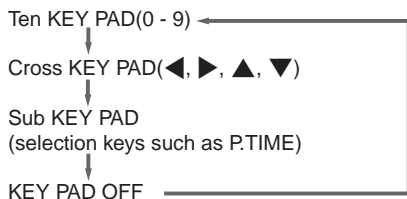

Notes:

* The KEY PAD displayed in the DVD video mode always starts from the "Cross KEY PAD" when the mode is engaged.

* The KEY PAD displayed in the video CD mode always starts from the "Ten KEY PAD" when the mode is engaged.

* Use either the "Cross KEY PAD" or the "Ten KEY PAD" according to the disc contents menu displayed in DVD video/video CD mode.

* Only the sub KEY PAD is displayed while you are driving a car.

* The KEY PAD is not displayed in the menu screen while you are driving a car.

Sub KEY PAD operation

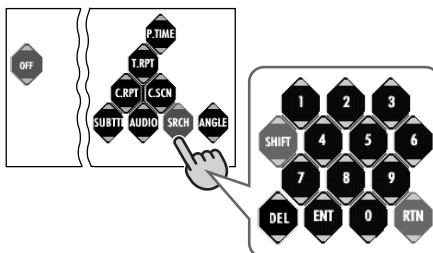

● Enter the title number or some other information to select directly

1. Touch the [SRCH] key to switch the KEY PAD.
2. Touch the [0]-[9] key that corresponds to the title number you desired. When you touch the wrong number ([0]-[9] key), you can cancel the key input by touching the [DEL] key.
 - DVD video mode: select the title number.
 - Video CD mode (with the PBC function turned off): select the track number.
 - CD mode: select the track number.
 - MP3 mode: select the file (track) number.
3. Touch the [ENT] key.
The specified title number is selected and playback starts.

● Function of the other keys

● In DVD video mode

To turn on/off the play time indication, touch the [P.TIME] key.

To switch the playtime, touch the [P.TIME] key for 1 second or longer.

To perform title repeat, touch the [T.RPT] key.

To perform chapter repeat, touch the [C.RPT] key.

To perform chapter scan, touch the [C.SCN] key.

To switch the subtitles, touch the [SUBTTL] key.

To switch the language, touch the [AUDIO] key.

To switch the angle function, touch the [ANGLE] key.

● In video CD mode:

To turn on/off the play time indication, touch the [P.TIME] key.

To switch the playtime, touch the [P.TIME] key for 1 second or longer.

To perform track repeat, touch the [T.RPT] key.

DVD Video Player Operations

- To perform track scan, touch the [T.SCN] key.
- To perform track random, touch the [T.RDM] key.
- To turn on/off Play Back Control function, touch the [PBC] key.
- To switch the language, touch the [AUDIO] key.

• In CD mode:

- To switch the playtime, touch the [P.TIME] key for 1 second or longer.
- To perform track repeat, touch the [T.RPT] key.
- To perform track scan, touch the [T.SCN] key.
- To perform track random, touch the [T.RDM] key.

• In MP-3 mode:

- To switch the playtime, touch the [P.TIME] key for 1 second or longer.
- To perform folder repeat, touch the [F.RPT] key.
- To perform folder scan, touch the [F.SCN] key.
- To perform folder random, touch the [F.RDM] key.
- To perform file (track) repeat, touch the [T.RPT] key.
- To perform file (track) scan, touch the [T.SCN] key.
- To perform file (track) random, touch the [T.RDM] key.

- To return to the STANDARD screen, touch the [OFF] key.

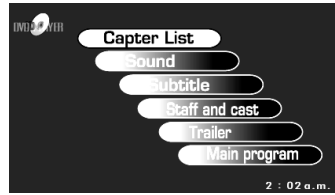

2. To cancel to the DVD menu, press the [MENU] button again.

- * To select the menu contents, press the [KEY PAD] button and use either the "Cross KEY PAD" or the "Ten KEY PAD" according to the disc contents menu.

Switching KEY PAD position

When the KEY PAD becomes difficult to view in the menu display, you can move it to the other side of the screen.

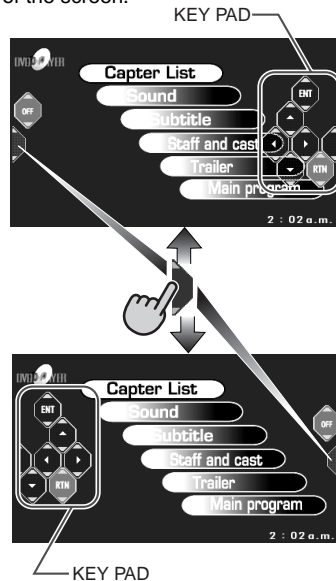

DVD Video Operations

Watching a DVD-Video

After disc loading, the play mode is automatically engaged.

- Button operation may not be allowed depending on the story of the disc.

● After the menu screen is displayed

For normal DVD-Video discs, the menu screen appears.

After the menu screen is displayed, select an item in the following operations and play it back.

Showing the DVD menu

1. Press the [MENU] button during playback. The DVD menus appears. The displayed contents may differ, depending on the DVD software.
 - Example showing menu display

Stopping playback

1. Press and hold the [▶/||] button for 1 second or longer during playback. Playback stops.
2. To resume playback. Press the [▶/||] button, and playback resumes from the scene where playback is stopped.

Pausing playback

1. Press the [▶/II] button during playback. Playback pauses.
2. To resume playback. Press the [▶/II] button, and playback resumes.

Slow playback

1. Press the [▶/II] button then press and hold the [⏪] button. While the button is being pressed, slow playback continues at the speed 1/2 times the normal playback.
 - Slow playback cannot be performed in the backward direction. In addition, audio cannot be reproduced during slow playback.

Skipping a chapter (searching)

About chapter

Chapter means a small segment to divide the data area of the disc.

1. Press the [◀◀] or [▶▶] button during playback.

Chapters are skipped, as many as the times the button is pressed, and playback starts.

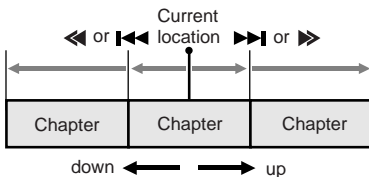

- Press the [▶▶] button, and playback starts from the beginning of the next chapter.
- Press the [◀◀] button, and playback starts from the beginning of the current chapter. When this button is pressed again within about 2 seconds, playback starts from the beginning of the previous chapter.
- The unit may return to the menu screen when the [▶▶] button or [◀◀] button is pressed.

Fast forward and fast backward

1. Press and hold the [◀◀] button or [▶▶] button during playback.

Press and hold the button, and the playback speed becomes 4-time faster first and then 16-time faster 3 seconds later. Release the button, and the normal speed is restored.

- No audio is reproduced during fast forward and fast rewind operation.

- The fast forward and fast rewind speed may differ depending on the disc.
- The menu screen may appear when the button is pressed.

Searching with a chapter/title number

You can locate the beginning of the scene using the chapter numbers or title numbers recorded on the DVD-Video disc.

1. Display the sub KEY PAD using the procedures described in the section "KEY PAD operation".
2. Touch the [SRCH] key.

Each time you touch the [SHIFT] key, you can switch between title number input "[T**]" and chapter number input "[C**]".

• Title

A large segment to divide the data area of the disc.

• Chapter

A small segment to divide the data area of the disc.

2. Input the number of the title that you want to play back with the [0] to [9] key.
3. Touch the [ENT] key.

Playback starts from the scene of the input title number or chapter number.

- If the input title number does not exist or searching with a title number is not allowed, the following message appears to invalidate the input.

⊘ INVALID

Scan playback

Scans and plays back all chapters recorded on the DVD-Video, the first 10 seconds for each.

1. Touch the screen and touch the [SUB MODE] key.
2. Touch the [CHAPTER SCAN] key, then touch the [RTN] key.

After scan playback of all chapters on the disc, chapter scanning through the same disc is performed again.

Depending on the disc, the menu may appear again after scan playback of all chapters within the title.

3. Touch the [CHAPTER SCAN] key again, and scan playback is turned off.

DVD Video Player Operations

Repeat playback

This operation plays back chapters/titles recorded on the DVD-Video repeatedly.

● Chapter repeat:

Plays back one chapter repeatedly.

1. Touch the screen and touch the [SUB MODE] key.
2. Touch the [CHAPTER REPEAT] key, then touch the [RTN] key.
3. Touch the [CHAPTER REPEAT] key, repeat playback is turned off.

● Title repeat:

Plays back all chapters within the title repeatedly.

1. Touch the screen and touch the [SUB MODE] key.
2. Touch the [TITLE REPEAT] key, then touch the [RTN] key.
3. Touch the [TITLE REPEAT] key, repeat playback is turned off.

TOP function

The TOP function resets the DVD player to the first chapter of the track.

1. Press the [BND] button to playback the first chapter(chapter No. 1).

Using the title menu

On DVD discs containing two or more titles, you can select from the title menu for playback.

1. Press and hold the [MENU] button for 1 second or longer during playback.

The title menu screen appears.

- Press the [MENU] button, and playback resumes from the scene played back before [MENU] button is pressed.
 - Depending on the disc, the title menu cannot be called.
2. Touch the [▲], [▼], [◀] or [▶] key to select the item.
 - Depending on the disc, items cannot be selected with the ten-key buttons.
 3. Touch the [ENT] key.

Switching among languages

On discs in which two or more audios or audio languages have been recorded, you can switch among the audio languages during playback.

1. Display the sub KEY PAD using the procedures described in the section "KEY PAD operation".
2. Touch the [AUDIO] key during playback. Each time you touch the key, you can switch among audio languages.
 - Depending on the disc, up to 8 audios may be recorded. For details, see the mark of the disc (Ⓢ): Indicates that 8 audios have been recorded).
 - When the power is turned on and when the disc is changed with a new one, the language set at the time of factory shipment is selected. If that language has not been recorded, the language specified on the disc.
 - Depending on the disc, switching may be completely impossible or impossible on some scenes.
 - It may take time to switch among audios.

Switching subtitles

On DVD discs in which two or more subtitle languages have been recorded, you can switch among the subtitle languages during playback.

1. Display the sub KEY PAD using the procedures described in the section "KEY PAD operation".
2. Touch the [SUB TTL] key during playback. Each time you touch the key, you can switch among subtitles.
 - Depending on the disc, up to 32 kinds of subtitles may be recorded. For details, see the mark of the disc (Ⓢ): Indicates that 8 kinds of subtitles have been recorded).
 - Depending on the disc, switching may be completely impossible or impossible on some scenes.
 - It may take time to switch among subtitles.

● To turn off subtitles

1. Touch the [SUB TTL] key several times, and subtitles are turned off.

In initial setting:

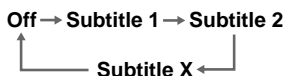

Switching angles

On DVD discs in which video images have been recorded in two or more angles, you can switch among the angles during playback.

1. Display the sub KEY PAD using the procedures described in the section "KEY PAD operation".
2. Touch the [ANGLE] key during playback. Each time you touch the key, you can switch among angles.
 - Depending on the disc, up to 9 angles may be recorded. For details, see the mark of the disc (☉₂); Indicates multi-angle.
 - Depending on the disc, angles may switch smoothly or switch with a momentary still image.
 - When the power is turned on and when the disc is changed with new one, the language set at the time of factory shipment is selected. If that language has not been recorded, the language specified on the disc.
 - Depending on the disc, switching may be completely impossible or impossible on some scenes.
 - It may take time to switch among angles.
 - Depending on the disc, scenes recorded in two or more angles may be played back.

Displaying the playback status

1. Press the [DISP] button or touch the [P.TIME] key in the sub KEY PAD display (using the procedures described in the section "KEY PAD operation") during playback. Each time you press the button or touch the key, you can switch between display (ON) and non-display (OFF) of the playback status.

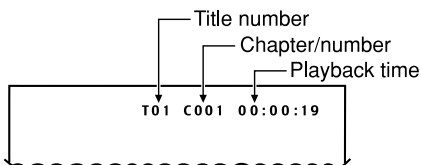

- Depending on the playback status or disc, the following indication may appear.

Each time you touch the key for about 1 second or longer, you can switch among time display.

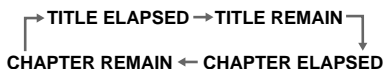

- **CHAPTER ELAPSED:**
Elapsed time of the chapter
- **CHAPTER REMAIN:**
Remaining time of the chapter
- **TITLE ELAPSED:**
Elapsed time of the title
- **TITLE REMAIN:**
Remaining time of the title

Watching a video CD

After disc loading, the play mode is automatically engaged.

- Button operation may not be allowed depending on the story of the disc.

■ After the menu screen is displayed

For V-CD discs equipped with the PBC (Play Back Control) function, the menu screen appears. After the menu screen is displayed, select an item in the following operations and play it back.

Showing the V-CD menu (for V-CD discs with PBC)

This key does not function on some discs.

1. Press the [MENU] button during playback. The V-CD menu appears.

The displayed contents may differ, depending on the V-CD software.

- Example showing menu display



- * To select the menu contents, press the [KEY PAD] button and use either the "Cross KEY PAD" or the "Ten KEY PAD" according to the disc contents menu.

DVD Video Player Operations

Stopping playback

1. Press the [▶/II] button for 1 second or longer during playback. Playback stops.

● When the PBC is turned on

Resume playback

When the Play/pause [▶/II] button is pressed, the disc plays from the beginning.

● When the PBC is turned off

To resume playback, press the [▶/II] button, and playback resumes from the scene where playback is stopped.

Pausing playback

1. Press the [▶/II] button during playback. Playback pauses.
2. To resume playback, press the [▶/II] button, and playback resumes.

Slow playback

1. Press the [▶/II] button then press and hold the [▶/II] button.

While the button is being pressed, slow playback continues at the speed 1/2 times the normal playback.

- Slow playback cannot be performed in the backward direction. In addition, audio cannot be reproduced during slow playback.

Skipping a track (searching)

1. Press the [◀◀] or [▶▶] button during playback.

The track is skipped and playback starts.

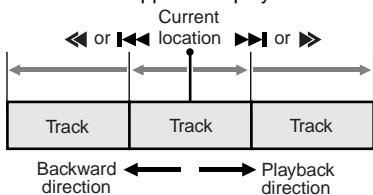

- Press the [▶▶] button, and playback starts from the beginning of the next track.
- Press the [◀◀] button, and playback starts from the beginning of the current track. When this button is pressed again within about 2 seconds, playback starts from the beginning of the previous track.

* This operation cannot be performed on some discs with PBC.

Fast forward and fast backward

1. Press and hold the [◀◀] button or [▶▶] button during playback.

Press and hold the button, and the playback speed becomes 4-time faster first and then 16-time faster 3 seconds later. Release the button, and the normal speed is restored.

- No audio is reproduced during fast forward and fast rewind operation.
- The unit may return to the menu screen when the button is pressed.

Searching with a track number

This operation allows searching with the track numbers recorded on the video CDs.

1. Display the sub KEY PAD using the procedures described in the section "KEY PAD operation".
2. Touch the [SRCH] key.
3. Input the number of the track that you want to play back with [0] to [9] key.
4. Touch the [ENT] key.

Playback starts from the scene of the input track number.

- If the input track number does not exist or searching with a track number is not allowed, the following message appears to invalidate the input.

INVALID

* If you are playing a disc with PBC and the PBC function is engaged, this operation may not be performed.

Changing audio output

You can change the audio output method.

1. Display the sub KEY PAD using the procedures described in the section "KEY PAD operation".
2. Touch the [AUDIO] key during playback.

Each time you touch the key, you can switch among audio output methods.

LL (Left) → RR (Right) → LR (Stereo)

Other various play functions

1. Touch the screen, the MENU screen appears.
2. Touch the [SUB MODE] key in the MENU screen to show SUB MODE.

3. Touch the touch key of the function you want to play.

●[TRACK SCAN]

This operation scans and plays back all tracks on the disc, the first 10 seconds for each.

"**TRACK SCN**" will appear in the screen during play.

●[TRACK REPEAT]

This operation plays back one track recorded on the video CD repeatedly.

"**TRACK RPT**" will appear in the screen during play.

●[TRACK RANDOM]

This operation plays back all tracks on the disc in no particular order.

"**TRACK RDM**" will appear in the screen during play.

4. To cancel play, touch the touch key again.
 - To return to the original screen, touch the [RTN] key.

If you are playing a disc with PBC and the PBC function is engaged, this operation can not be performed.

Displaying the playback status

1. Press the [DISP] button during playback.

Each time you press the button, you can switch between display (ON) and non-display (OFF) of the playback status.

 - Depending on the playback status or disc, the following indication may appear.
2. Display the sub KEY PAD using the procedures described in the section "**KEY PAD operation**".
3. Touch the [P.TIME] key during playback.

Each time you touch the key, you can switch among time display.



Note:

- Depending on some discs, the [P.TIME] indication may not be displayed on some scenes. Also, it may occur that the P.TIME operation does not work. When this happens, the indication "INVALID" will appear.

On/off of Playback Control

- * This function is enabled only using the remote control unit.

- * The factory default setting is "ON".

On video CDs equipped with Play Back Control function, you can turn it on/off.

1. Press the [PBC] button on the remote control unit.

Each time you press the button, you can switch between on and off.

When the PBC is turned on or off, the disc plays from the beginning.

●Playback control (PBC)

This control signal is recorded on a Video CD for version 2.0 and used to control playback. Using pre-recorded menu screens in the Video CD with PBC, you can enjoy playback of software with a simplified dialog function or software with search function. You can also enjoy a still picture at high or standard resolution.

●When PBC is on

If one of the following operations is done, the disc plays from the beginning.

When the [FUNC] button is pressed to switch to some other mode, and the DVD player mode is returned again.

When the [▶/II] button is pressed to play the disc again after play is stopped by pressing and holding the [▶/II] button for 1 second or longer.

When the ACC switch of a car is turned on/off.

Listening to a CD

- * This unit is a CD TEXT compatible model.

This unit supports the display of the DISC TITLE, TRACK TITLE and ARTIST of the CD TEXT.

After disc loading, the play mode is automatically engaged.

Note:

This unit supports only CD TEXT in English. Also, some character data may not be reproduced properly on the display.

Pausing playback

1. Press the [▶/II] button during playback.

Playback pauses.
2. To resume playback, press the [▶/II] button, and playback resumes.

DVD Video Player Operations

Skipping a track (searching)

1. Press the [◀◀] or [▶▶] button during playback.

Tracks are skipped, as many as the times the button is pressed, and playback starts.

- Press the [▶▶] button, and playback starts from the beginning of the next track.
- Press the [◀◀] button, and playback starts from the beginning of the current track. When this button is pressed again within about 2 seconds, playback starts from the beginning of the previous track.

TOP function

The TOP function resets the DVD player to the first track of the disc.

1. Press the [BND] button to playback the first track (track No. 1).

Fast forward and fast backward

1. Press and hold the [◀◀] button or [▶▶] button during playback.

Press and hold the button, and the playback speed becomes 4-time faster first and then 8-time faster 3 seconds later. Release the button, and the normal speed is restored.

Searching with a track number

This operation allows searching using the track numbers recorded on the CDs.

1. Press the [KEY PAD] button and touch the [SRCH] key.
2. Input the number of the track that you want to play back with [0] to [9] key.
3. Touch the [ENT] key.

Playback starts from the scene of the input track number.

- If the input track number does not exist or searching with a track number is not allowed, the following message appears to invalidate the input.

INVALID

Scan playback

This operation scans and plays back all tracks recorded on the disc, the first 10 seconds for each.

1. Touch the screen and touch the [SUB MODE] key.

2. Touch the [TRACK SCAN] key, then touch the [RTN] key.

Touch the [TRACK SCAN] key again, and scan playback is turned off.

Repeat playback

This operation plays back tracks recorded on the CD repeatedly.

1. Touch the screen and touch the [SUB MODE] key.
2. Touch the [TRACK REPEAT] key, then touch the [RTN] key.

Touch the [TRACK REPEAT] key again, and repeat playback is turned off.

Random playback

This operation plays back all tracks on the disc in no particular order.

1. Touch the screen and touch the [SUB MODE] key.
2. Touch the [TRACK RANDOM] key, then touch the [RTN] key.
Touch the [TRACK RANDOM] key, and random playback is turned off.

Changing the display of the playback status

1. Press the [KEY PAD] button and touch the [P.TIME] key for 1 second or longer during playback.

Each time you touch the key, you can switch among time display.

TRACK ELAPSED → TRACK REMAIN

Displaying CD titles

This unit can display title data for CD-text CDs.

* This function is enabled only when the panel is open.

1. Press the [DISP] button.
Disc title, track title and artist title are displayed. Press the [DISP] button again to return to the previous mode.

Listening to an MP3

This unit is a ID3 Tag compatible model.

This unit supports the title, artist and album display of the ID3 Tag versions 1 and 1.1.

After disc loading, the play mode is automatically engaged.

What is MP3?

MP3 is an audio compression method and classified into audio layer 3 of MPEG standards. This audio compression method has penetrated into PC users and become a standard format.

This MP3 features the original audio data compression to about 10 percent of its initial size with a high sound quality. This means that about 10 music CDs can be recorded on a CD-R disc or CD-RW disc to allow a long listening time without having to change CDs.

Note:

- Some CDs recorded on CD-R mode may not be usable.

Precautions when creating an MP3 disc

● File extensions

1. Always add a file extension “.MP3” or “.mp3” to an MP3 file by using single byte letters. If you add a file extension other than specified or forget to add the file extension “.MP3” or “.mp3”, the file cannot be played. In addition, if you use upper case and lower case letters (capital and small letters) mixedly for file extensions, normal play may not be possible.
2. Files without MP3 data will not play.

● Logical format (File system)

1. When writing an MP3 file on a CD-R disc, please select “**ISO9660 level 1 or level 2 (without including expansion format)**” as the writing software format. Normal playback may not be possible if the disc is recorded on another format.
2. The folder name and filename can be displayed as the title during MP3 play but the title must be within 31 and 27 single byte alphabetical letters and numerals for the folder name and filename, respectively (without including an extension). Entering more letters or numerals than specified may cause an incorrect display.

● Folder structure

1. A disc with a folder having more than 8 hierarchical levels will conflict with the ISO9660 and playback will be impossible.

● Number of files or folders

1. A total of 255 files and folders are allowed. (However, the maximum number of folders must be within 254.) When the number of files and folders is more than 256, playback of tracks in excess of that number is impossible.

2. Tracks are played in the order that they were recorded onto a disc. (Tracks might not always be played in the order displayed on the PC.)

- Some noise may occur depending on the type of encoder software used while recording.
- Files created using LAME (Lame Aint MP3 Encoder) may not be played properly.
- In case of a track recorded at VBR (variable bit rate), the display for the play time of the track may be slightly different from the actual play time. Also, the recommended value of VBR ranges from 64 kbps to 320 kbps.
- Depending on the damage conditions of a file, it may occur that the file is not played and the next file is played instead. Also, if the damage is in a severe condition, play stops showing the “**DISC ERROR**” display.

After disc selection, the play mode is automatically engaged.

Note:

If ID3 Tag information was entered with 2-byte characters, it may occur that the characters are not reproduced properly on the display.

Pausing playback

1. Press the [▶/||] button during playback. Playback pauses.
2. To resume playback, press the [▶/||] button again, and playback resumes.

Skipping a track (searching)

1. Press the [◀◀] or [▶▶] button during playback.

Tracks are skipped, as many as the times the button is pressed, and playback starts.

- Press the [▶▶] button, and playback starts from the beginning of the next track.
- Press the [◀◀] button, and playback starts from the beginning of the current track. When this button is pressed again within about 2 seconds, playback starts from the beginning of the previous track.

* This operation skips the track over the folder.

DVD Video Player Operations

Fast forward and fast rewind

1. Press and hold the [◀◀] button or [▶▶] button during playback.

Press the button, and the playback speed becomes 4-time faster first and then 8-time faster 3 seconds later. Release the button, and the normal speed is restored.

Selecting a file (track) on the screen

1. Press the [MENU] button during playback.
Files (track) are displayed.
2. Touch the [▲] or [▼] key to select a file and touch the [ENT] key.
3. Touch the [RTN] key to select a folder. The folder selection screen appears.
4. Touch the [▲] or [▼] key to select the folder and touch the [ENT] key. The file selection screen is returned.

* If no further operation is performed for 7 seconds, the STANDARD screen is returned.

Playback by selecting a folder and file (Direct select mode)

This operation allows searching using the folder and file (track) numbers recorded on the MP3 disc.

1. Press the [KEY PAD] button and touch the [SRCH] key.
Each time you touch the [SHIFT] key, you can switch between "T000" for file (track) number input and "F000" for folder number input.
2. Input the number for the file (track) or folder that you want to play back with [0] to [9] key.
3. Touch the [ENT] key.

When you select the folder number playback starts from Track 1 of the input folder number.

When you are searching for some other folder and track while a file is being played, pressing the [MENU] button will return to the file being played.

Searching a desired file (Track scan playback)

● About file scan playback

This operation plays back all files recorded on the disc, about 10 seconds for each.

1. Touch the screen and touch the [SUB MODE] key.
2. Touch the [TRACK SCAN] key, then touch the [RTN] key.
The monitor displays "TRACK SCN". Scan playback starts from the next file.
3. To cancel file scan playback, touch the [TRACK SCAN] key again. The playback status indication "TRACK SCN" goes off from the monitor and the file currently being played back continues.

Searching for a desired folder (Folder scan playback)

This operation plays back the first files of all folders on the MP3 disc, about 10 seconds for each.

1. Touch the screen and touch the [SUB MODE] key.
2. Touch the [FOLDER SCAN] key, then touch the [RTN] key.
The monitor displays "FOLDER SCN" and folder scan playback starts.
 - Scan playback starts from the first file of the next folder to the one currently being played back.
3. To cancel folder scan playback, touch the [FOLDER SCAN] key again. The playback status indication "FOLDER SCN" goes off from the monitor and the file currently being played back continues.

Listening to one file repeatedly (Track repeat playback)

This operation plays back the file currently being played back repeatedly.

1. Touch the screen and touch the [SUB MODE] key.
2. Touch the [TRACK REPEAT] key, then touch the [RTN] key. The monitor displays "TRACK RPT" and file repeat playback starts.
3. To cancel file repeat playback, touch the [TRACK REPEAT] key again. The playback status indication "TRACK RPT" goes off from the monitor and the file currently being played back continues in normal playback.

Listening to files in a folder repeatedly (Folder repeat playback)

This operation plays back files in an MP3 folder repeatedly.

1. Touch the screen and touch the [SUB MODE] key.
2. Touch the [FOLDER REPEAT] key, then touch the [RTN] key. The monitor displays "FOLDER RPT" and folder repeat playback starts.
3. To cancel folder repeat playback, Touch the [FOLDER REPEAT] key again.
The playback status indication "FOLDER RPT" goes off from the monitor and the file currently being played back continues in normal playback.

Listening to files in a random order (Track random playback)

This operation plays the files in the folder in a random order.

1. Touch the screen and touch the [SUB MODE] key.
2. Touch the [TRACK RANDOM] key, then touch the [RTN] key. The monitor displays "TRACK RDM" and random playback starts.
3. To cancel file random playback, touch the or [TRACK RANDOM] key again.
The playback status indication "TRACK RDM" goes off from the monitor and the file currently being played back continues in normal playback.

Listening to tracks in a random order (Folder random playback)

This operation plays back tracks recorded on the disc in no particular order.

1. Touch the screen and touch the [SUB MODE] key.
2. Touch the [FOLDER RANDOM] key, then touch the [RTN] key. The monitor displays "FOLDER RDM" and folder random playback starts.
3. To cancel folder random playback, touch the or [FOLDER RANDOM] key again.
The playback status indication "FOLDER RDM" goes off from the monitor and the track currently being played back continues in normal playback.

Changing the display of the playback status

1. Press the [KEY PAD] button and touch the [P.TIME] key for 1 second or longer during playback.
Each time you touch the key, you can switch among time display.

TRACK ELAPSED → TRACK REMAIN
↑

TOP function

The TOP function resets the DVD player to the first track of the disc.

1. Press the [BND] button to playback the first track(track No. 1).

Displaying MP3 ID3-TAG titles

ID3 information such as title, artist and album title can be displayed for an MP3 file containing ID3 Tag information.

- * This function is enabled only when the panel is open.
1. Press the [DISP] button.
Title, artist and album title are displayed.
Press the [DISP] button again to return to the previous mode.
- * In case of an MP3 file without ID3-TAG data, "NO ID3 TAG DATA" appears in the display then return to the STANDARD screen.

VISUAL Operations

This function is available when a VTR, etc. is connected to the visual 1 or visual 2 terminal.

* The visual 1 mode is not available when a DVD changer is connected to the visual 1.

⚠ WARNING

For your safety, the driver should not watch the VTR, etc. or operate the controls while driving. Please note that watching and operating the VTR, etc. while driving are prohibited by law in some countries.

Switching to the VISUAL mode

Notes:

• For your safety, the VRX935VD has a safety function which turns off the picture when the car is moving, so only the audio can be heard. The picture can only be watched when the car is stopped and the parking break is applied.

1. Press the **[FUNC]** button and select the VISUAL mode.
2. Press the **[BAND]** button to select the VISUAL1 or VISUAL2.

Switching the VTR system between NTSC and PAL

* This function is enabled only when the panel is open.

Switch to the VISUAL/VTR in TV mode you use.

1. Press the **[ADJ]** button to switch to the ADJUST MODE menu.
2. Touch the **[NTSC/PAL]** key, **[NTSC]** key and **[PAL]** key appears in the display.
3. Touch the **[NTSC]** key or **[PAL]** key to select "NTSC" or "PAL".

Adjusting the brightness and tone of color

Notes:

- This function is not available when the display is stored.
- The HUE setting can be adjusted only when the NTSC mode is selected.
- Switch to the VISUAL/DVD player(DVD video or video CD)/DVD changer/TV mode you see.

1. Press the **[ADJ]** button to switch to the ADJUST MODE menu.
2. Touch the **[MONI ADJ]** key to display **[BRIGHT]**, **[HUE]** and **[COLOR]** key. Touch the **[BRIGHT]**, **[HUE]** and **[COLOR]** key to

adjust BRIGHT, HUE and COLOR.

● "BRIGHT":

Adjust the brightness of the display.

● "HUE":

Adjust the tone of color (red is emphasized or green is emphasized)

- This operation is available only when the car is stopped and the parking brake is applied.

● "COLOR":

Adjust the color saturation.

- This operation is available only when the car is stopped and the parking brake is applied.

3. Operate the touch key to adjust a level.

● "BRIGHT":

[-] key or **[+]** key

● "HUE":

[R] key or **[G]** key

● "COLOR":

[-] key or **[+]** key

4. When adjustment is made, touch the **[RTN]** key to return to the ADJUST MODE menu.

Touch the **[RTN]** key again to return to the STANDARD screen.

* To return from the adjust a level display to the STANDARD screen, press the **[ADJ]** button once again.

Changing over monitor display size

* This function is available only when the panel is open.

Note

- This function is not available while you are driving.
- Switch to the VISUAL/DVD player(DVD video or video CD)/DVD changer/TV mode you see.

1. Press the **[DISP]** button for 1 second or longer to change over the monitor display size. Each time you press the **[DISP]** button, the monitor display size changes in the following order:

"NORMAL" → "WIDE" → "F.WIDE" → "CINEMA" → "NORMAL"

● "NORMAL": (normal display)

There is a black area at both right and left ends of a display. In case of normal TV broadcasting (4:3), the image can be shown without being cut or deformed.

- **“WIDE”**: (wide mode)

The image at right and left ends in a display elongates horizontally.

- **“F.WIDE”**: (full wide mode)

The whole image elongates horizontally.

- **“CINEMA”**: (cinema mode)

The image at both top and bottom in a display disappears.

Notes:

- When a normal 4:3 size image, not being a wide one, is viewed by displaying it fully on a wide monitor display in a wide mode or a full-wide mode, a part of the peripheral image will be lacking or deformed. In deference to the intention of producer, an original image can be viewed in a normal mode.
- During superimposed display, it becomes a full-wide mode.
- When the monitor display size mode is changed, only the monitor display size indication superimposed on the screen (“**NORMAL**”, “**WIDE**”, “**F.WIDE**” or “**CINEMA**”) will be changed, then the corresponding display size mode will be engaged.

- The rear monitor lock displays the image of an external device (VTR, TV game console, etc.) connected to the Visual 1 terminal.
- When a DVD changer connected to the CeNET is connected to the Visual 1 terminal, the rear monitor lock cannot be used.
- When 2-ZONE or 3-ZONE is used, the sound from an external device (VTR, TV game console, etc.) can only be heard from headphones connected to the external device.
- A rear monitor is a separately sold accessory.

Monitoring the CCD camera

The CCD camera can be connected to this unit. For the power supply of the camera, mount the power box sold separately (CAA-188).

Notes:

- This function is not available when the display is stored.

Switching the 2-ZONE/3-ZONE

The front monitor lock and rear monitor lock allows you to enjoy 2-ZONE and 3-ZONE.

2-ZONE:

Use the front monitor lock (or rear monitor lock) to lock the receiver screen image (or image from a separately sold rear monitor) to switch the speaker sound to a sound mode that differs from the sound accompanying the image.

3-ZONE

When a separately sold rear monitor is connected, use the front or rear monitor lock to lock the image of the receiver and that of the rear monitor and to switch the speaker sound to a sound mode that differs from the sound accompanying the image.

Notes:

- The front monitor lock displays the image of an external device (VTR, TV game console, etc.) connected to the Visual 2 terminal.

VISUAL Operations

● Lock system monitor image and sound

	2 ZONE			3 ZONE
	Front monitor lock		Rear monitor lock	
(*1)	Visual 2 connection [OTHERS]	Visual 2 connection [NAVI]		
Front image (receiver screen)	Image of device connected to the Visual 2 terminal (*3)	Image of device connected to the Visual 2 terminal	Displays image of mode selected using the [FUNC] button	Image of device connected to the Visual 2 terminal (*3)
Rear monitor image (separately sold)	Image of device connected to the Visual 2 terminal (*3)	Displays image of mode selected using the [FUNC] button (*2)	Image of device connected to the Visual 1 terminal	
Vehicle speaker sound	Plays sound of mode selected using the [FUNC] button			

*1 A device connected to the Visual 2 terminal should be set up as described in the section “**Switching Connect.**”

*2 No image is displayed on the rear monitor when a non-image mode such as radio, SIRIUS, CD, etc. is engaged.

*3 For safety reasons, this image is not displayed when the vehicle is moving. The picture can be watched only when the vehicle is standing still and the parking brake is engaged.

2-ZONE: 1 (front monitor lock)

1. Press the [M.L] button.
2. Press the [FUNC] button to select the desired mode.
3. To cancel the monitor lock, press the [M.L] button.

The screen shows the image of the selected mode.

* When the front monitor lock is engaged, [MENU], [LIST], [KEY PAD], [ADJ] and [A-M] button cannot be used. Cancel the monitor lock when you wish to use these buttons.

2-ZONE: 2 (rear monitor lock)

1. Press the [ADJ] button to display the ADJUST MODE menu.
2. Touch the [REAR MONI LOCK] key and the [ON] key.
3. Touch the [RTN] key or press the [ADJ] button.
4. To cancel the monitor lock, press [ADJ] button, touch the [REAR MONI LOCK] key and the [OFF] key.

5. Touch the [RTN] key or press the [ADJ] button.

The monitor lock is now canceled.

Locking the front monitor and rear monitor (3-ZONE)

1. Lock the rear monitor by performing the instructions in steps 1 to 3 above.
2. Press the [M.L] button to lock the front monitor.
3. Press the [FUNC] button.
The image for the selected mode is displayed for about 5 seconds after which the front monitor lock image is displayed.
4. To cancel the monitor lock, press the [M.L] button.
5. To cancel the rear monitor lock, press the [ADJ] button, touch the [REAR MONI LOCK] key and the [OFF] key.

Switching CONNECT(connect)

Make the following settings when an external device is connected to the VISUAL 2 terminal.

- NAVI:** when a navigation system is connected
- * When a navigation system is connected, use the monitor lock function. Locking the monitor locks the screen size in F.WIDE mode (full wide) and the VTR system to NTSC.

OTHERS: for external devices other than a navigation system

NONE: when no external devices are connected

* The factory default setting is "**NONE**".

1. When the panel is open, press the [ADJ] button to display the ADJUST MODE menu.
2. Touch the [▼] key two times to select "**CONNECT**".
Touch the [CONNECT] key to select "**NAVI**" or "**OTHERS**" or "**NONE**".
3. Press the [ADJ] button again or touch the [RTN] key, the unit returns to the previous mode.

Note:

- When an optional DVD (CD/MD) changer is connected through the CeNET cable, this unit controls all DVD (CD/MD) changer functions. This unit can control a total of 2 changers (MD and/or CD and/or DVD).

CD/MD changer functions

Press the [FUNC] button and select the CD changer mode to start play. If 2 CD (MD) changers are connected, press the [FUNC] button to select the CD (MD) changer for play.

- * If "**NO MAGAZINE**" appears in the display, insert the magazine into the CD changer. "**DISC CHECKING**" appears in the display while the player loads (checks) the magazine.
- * If "**NO DISC**" appears in the display, eject the magazine and insert discs into each slot. Then, reinsert the magazine back into the CD changer.
- * If "**NO DISC**" appears in the display, load MDs into the MD changer.

⚠ CAUTION

CD-ROM discs cannot be played in the CD changer.

Pausing play

1. Press the [▶/||] button to pause play. "**PAUSE**" appears in the display.
2. To resume play, press the [▶/||] button again.
 - * When the panel is open, the same operation is also available by using the [▶/||] button in the panel.

Switching the CD TEXT titles

This operation is only possible when this unit is connected with a CD TEXT compatible CD changer.

You can select the CD TEXT titles among the disc titles, track titles and artist titles.

When the panel is closed:

1. Press the [DISP] button to show the SUB display. The disc title, track title or artist titles, user title is displayed.
2. Each time you press and hold the [DISP] button for 1 second or longer, the display toggles among the disc title, the track title or the artist titles, user title.

The selected title scrolls once.

CD/MD Changer Operations

When the panel is open:

1. Press the [DISP] button.
The disc title, track title, artist title and user title is displayed.
2. Touch the [DISC] key, [TRACK] key, [ARTIST] key or [USER] key to select the desired title.
The selected titles except for the user title scroll once.
3. Press the [DISP] button again.
The STANDARD screen is returned and the selected title is displayed.

Switching disc titles and track titles (MD)

This unit can display disc titles and track titles already entered on MDs. Titles up to 256 characters long can be displayed by scrolling the titles.

* Titles cannot be entered for MDs with this unit.

When the panel is closed:

1. Press the [DISP] button to show the SUB display. The disc title or track title is displayed.
2. Each time you press and hold the [DISP] button for 1 second or longer, the display toggles between the disc title and the track title.
The selected title scrolls once.

When the panel is open:

1. Press the [DISP] button.
The disc title and track title are displayed.
2. Touch the [DISC] key or [TRACK] key to select the desired title.
The selected titles scroll once.
3. Press the [DISP] button again.
The STANDARD screen is returned and the selected title is displayed.

Selecting an MD

When the panel is closed:

Each of the [DIRECT] button corresponds to an MD loaded into the MD changer.

Press the [DIRECT] button (1 to 6) and select the desired MD.

When the panel is open:

1. Touch the screen or press the [LIST] button.

2. Each of the [DIRECT] key corresponds to an MD loaded into the MD changer.
Touch the [DISC SELECT] key in the display, the [DIRECT] key (1 to 6) appears in the display.
Touch the [DIRECT] key (1 to 6) and select the desired MD.

Selecting a CD

When the panel is closed:

Each of the [DIRECT] buttons corresponds to a disc loaded into the magazine.

●Selecting a disc from 1 to 6

Press the corresponding [DIRECT] button (1 to 6) to select the desired disc.

●Selecting a disc from 7 to 12 (only when a 12 disc CD changer is used.)

Press the corresponding [DIRECT] button (1 to 6) for 1 second or more, then select the desired disc.

When the panel is open:

Each of the [DIRECT] keys corresponds to a disc loaded into the magazine.

●Selecting a disc from 1 to 6

1. Touch the screen or press the [LIST] button.
2. Touch the [DISC SELECT] key in the display, the [DIRECT] key (1 to 6) appears in the display.
Touch the corresponding [DIRECT] key (1 to 6) to select the desired disc.

●Selecting a disc from 7 to 12 (Only when a 12 disc CD changer is used.)

Touch the [DISC SELECT] key again, the [DIRECT] key (7 to 12) appears in the display.
Touch the corresponding [DIRECT] key (7 to 12) to select the desired disc.

Switching to a next disc. (Disc Up function)

The disc up function plays from the first track (track No.1) of the next disc.

Press the [BAND] button.

Each time you press the [BAND] button, the disc changes to the next disc.

Selecting tracks with the KEY PAD

* This function displays the KEY PAD on the screen and allows you to select and repeat tracks you wish to listen to.

Press the [KEY PAD] button to display the KEY PAD.

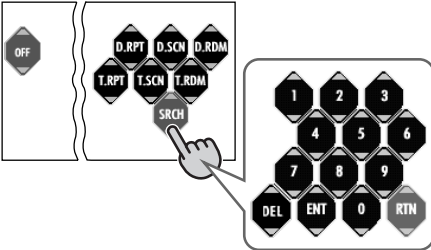

● Direct track selection

1. Touch the [SRCH] key to switch the KEY PAD.
2. Touch the [0] ~ [9] key corresponding with the track you desired. When you touch the wrong number ([0] ~ [9] key), you can cancel that to touch the [DEL] key.
3. Touch the [ENT] key.
The specified track is selected and playback starts.

● To repeat tracks,

touch the [T.RPT] key.

● To repeat discs,

touch the [D.RPT] key.

● To scan tracks,

touch the [T.SCN] key.

● To scan discs,

touch the [D.SCN] key.

● To play tracks at random,

touch the [T.RDM] key.

● To play discs at random,

touch the [D.RDM] key.

Selecting a track

● Track-up

1. Press the [▶▶] button to move ahead to the beginning of the next track.
2. Each time you press the [▶▶] button, the track advances ahead to the beginning of the next track.
* When the panel is open, the same operation is also available by using the [▶▶] button in the panel.

● Track-down

1. Press the [◀◀] button to move back to the beginning of the current track.
2. Press the [◀◀] button twice to move to the beginning of the previous track.
* When the panel is open, the same operation is also available by using the [◀◀] button in the panel.

Fast-forward/Fast-backward

● Fast-forward

Press and hold the [▶▶] button for 1 second or longer.

* When the panel is open, the same operation is also available by using the [▶▶] button in the panel.

● Fast-backward

Press and hold the [◀◀] button for 1 second or longer.

* When the panel is open, the same operation is also available by using the [◀◀] button in the panel.

Top function (CD)

The top function plays from the first track (track No. 1) of the disc.

● When playing a disc 1 to 6

Press the [DIRECT] button (1 to 6) with the same number as the CD playing.

● When playing a disc 7 to 12 (only when a 12 disc CD changer is used.)

Press the [DIRECT] button (1 to 6) with the same number as the CD playing for 1 second or longer.

Top function (MD)

The top function plays from the first track (track No. 1) of the disc.

Press the [DIRECT] button (1 to 6) with the same number that the MD playing.

* If an MD is not loaded in a slot of the MD changer, pressing the [DIRECT] button corresponding to its disc number is invalid.

CD/MD Changer Operations

Scan play

The scan play locates and plays the first 10 seconds of each track on a disc automatically. This function continues on the disc until it is cancelled or the mode is changed.

* The scan play is useful when you want to select a desired track.

1. Touch the screen or press the **[LIST]** button, the MENU screen appears.
2. Touch the **[SUB MODE]** key in the STANDARD screen to show SUB MODE.

Touch the **[TRACK SCAN]** key to start scan play. "TRACK SCN" lights in the display.

3. Touch the **[TRACK SCAN]** key again to cancel the scan play. Current track continues to play.

Disc scan play

The disc scan play locates and plays the first 10 seconds of the first track on each disc in the currently selected CD (MD) changer. This function continues automatically until it is cancelled or the mode is changed.

* The disc scan play is useful when you want to select a desired CD (MD).

1. Touch the screen or press the **[LIST]** button, the MENU screen appears.
2. Touch the **[SUB MODE]** key in the MENU screen to show SUB MODE.

Touch the **[DISC SCAN]** key to start disc scan play. "DISC SCN" lights in the display.

3. Touch the **[DISC SCAN]** key again to cancel disc scan play. Normal disc play continues on the current track.

Repeat play

The repeat play continuously plays the current track. This function continues automatically until it is cancelled.

1. Touch the screen or press the **[LIST]** button, the MENU screen appears.
2. Touch the **[SUB MODE]** key in the MENU screen to show SUB MODE.

Touch the **[TRACK REPEAT]** key, to make repeat play starts. "TRACK REPEAT" lights in the display.

3. To cancel repeat play, touch the **[TRACK REPEAT]** key. "TRACK REPEAT" goes off from the display and the unit returns to normal play.

Disc repeat play

After all tracks in the current disc have been played, the disc repeat play automatically re-plays the current disc over from the first track. This function continues automatically until it is cancelled.

1. Touch the screen or press the **[LIST]** button, the MENU screen appears.
2. Touch the **[SUB MODE]** key in the MENU screen to show SUB MODE.

Touch the **[DISC REPEAT]** key, disc repeat play starts, "DISC REPEAT" light in the display.

3. To cancel disc repeat play, touch the **[DISC REPEAT]** key again. "DISC REPEAT" goes off from the display and the unit returns to normal play from the track being played.

Random play

The random play selects and plays individual tracks on the disc in no particular order. This function continues automatically until it is cancelled.

1. Touch the screen or press the **[LIST]** button, the MENU screen appears.
2. Touch the **[SUB MODE]** key in the MENU screen to show SUB MODE.

When you touch the **[TRACK RANDOM]** key, random play starts. "TRACK RANDOM" lights in the display.

3. To cancel random play, touch the **[TRACK RANDOM]** key again. "TRACK RANDOM" goes off from the display and the unit returns to normal play.

Disc random play

The disc random play selects and plays individual tracks or discs automatically in no particular order. This function continues automatically until it is cancelled.

1. Touch the screen or press the **[LIST]** button, the MENU screen appears.
2. Touch the **[SUB MODE]** key in the MENU screen to show SUB MODE.

When you touch the **[DISC RANDOM]** key, disc random play starts. "DISC RANDOM" lights in the display.

3. To cancel disc random play, touch the **[DISC RANDOM]** key again. "DISC RANDOM" goes off from the display and the unit returns to normal play from the track being played.

DVD Changer Operations

This function allows you to control a connected DVD changer in the same way as described in DVD player Operation.

For details on operations other than those described below, see DVD player Operation. For details on DVD changer precautions, refer to the supplied owner's manual.

Selecting a disc

When the panel is closed :

Each of the [DIRECT] button corresponds to a disc loaded into the DVD changer.

Press the [DIRECT] button (1 to 6) and select the desired disc.

When the panel is open :

Press the [LIST] button, otherwise press the [DISC SEL] button on the remote control unit.

Touch the [DIRECT] key (1 to 6) in the display or press the numeric button for the disc number (1 to 6) on the remote control unit to select the desired disc.

Switching to a next disc. (Disc Up function)

The disc up function plays from the first track (track No.1) of the next disc.

Press the [BAND] button.

Each time you press the [BAND] button, the disc changes to the next disc.

Disc Repeat playback

This operation plays back all tracks on the disc repeatedly.

There are 3 ways available :

- Press the [KEY PAD] button and touch the [D.RPT] key.
- Touch the screen and touch the [SUB MODE] key. Touch the [DISC REPEAT] key then touch the [RTN] key.
- Press the [RPT] button on the remote control unit 1 second or longer.

* To cancel the disc repeat play, touch the [D.RPT]/[DISC REPEAT] key or press the [RPT] button on the remote control unit.

TV Operations

TV functions

When an optional TV tuner is connected through the CeNET cable, this unit controls all TV tuner functions. To watch TV requires a TV tuner.

WARNING

For your safety, the driver should not watch the TV or operate the controls while driving. Please note that watching and operating the TV while driving are prohibited by law in some countries.

Watching TV

Notes:

- For your safety, the VRX935VD has a safety function which turns off the picture when the car is moving, so only the audio can be heard. The picture can only be watched when the car is stopped and the parking break is applied.

1. Press the [FUNC] button and select the TV mode.
2. Press the [BAND] button to select the desired TV band (TV1 or TV2). Each time the button is pressed, the input selection toggles between TV1 and TV2.
3. Press the [▶▶] or [◀◀] button to tune in the desired TV station.

* When the panel is open, the same operation is also available by using the [◀◀] and [▶▶] button in the panel.

Watching a video

The TV tuner has a VTR input terminal to which 1 external device can be connected. Connect a 12V video cassette player (VCP) or video cassette recorder (VCR) to the TV tuner input terminal.

1. Touch the screen or press the [LIST] button, the MENU screen appears.
2. Touch the [EXTRA SELECT] key in the MENU screen to select the [VTR] key.
3. To return to the TV broadcast, touch the screen again and touch the [EXTRA SELECT] key in the MENU screen to select the [TELEVISION] key.

TV Operations

Seek tuning

1. Press the [BAND] button and select the desired TV band (TV1 or TV2).
 - * If "MANU" is lit in the display, press and hold the [BAND] button for 1 second or longer. "MANU" in the display goes off and seek tuning is now available.
2. Press the [▶▶] or [◀◀] button to automatically seek a station. Press the [▶▶] button to automatically tune up the frequency band to the next available TV station; press the [◀◀] button to automatically tune down.
 - * When the panel is open, the same operation is also available by using the [◀◀] or [▶▶] button in the panel.

Selecting stations with the KEY PAD

* This function displays the KEY PAD on the screen enabling you to tune in through auto store, preset scan or by entering a frequency.

Press the [KEY PAD] button to display the KEY PAD.

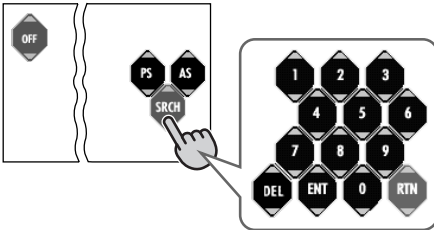

● Tuning in by selecting a frequency

1. Touch the [SRCH] key to switch the KEY PAD.
2. Touch the [0]–[9] key corresponding with the frequency you desired. When you touch the wrong number ([0]–[9] key), you can cancel that to touch the [DEL] key.
3. Touch the [ENT] key. The radio station you required would be tuned.

● To use auto store,

touch the [AS] key for about 2 seconds.

● To perform a preset scan,

touch the [PS] key.

● To cancel the KEY PAD display,

press the [KEY PAD] button or touch the [OFF] key.

Manual tuning

There are 2 ways available: Quick tuning and step tuning. When you are in the step tuning mode, the frequency changes one step at a time. In quick tuning mode, you can quickly tune the desired frequency.

1. Press the [BAND] button and select the desired band. (TV1 or TV2)
 - * If "MANU" is not lit in the display, press and hold the [BAND] button for 1 second or longer. "MANU" appears in the display and manual tuning is now available.
2. Tune into a station.

● Quick tuning:

Press and hold the [▶▶] or [◀◀] button for 1 second or longer to tune in a station.

● Step tuning:

Press the [▶▶] or [◀◀] button to manually tune in a station.

Note:

- Manual tuning is cancelled if you do not operate the unit for 7 seconds longer. (*Only when connecting the TTX7503Z or TTX7504Z with this unit)

Recalling a preset station

A total of 12 TV stations can be stored (6-TV1 and 6-TV2). This allows you to select your favorite TV stations and store them in memory for later recall.

There are 2 ways available to recall the preset station.

● Using the [DIRECT] button.

1. Press the [BAND] button and select the desired TV band. (TV1 or TV2)
2. To recall a stored TV station, press the desired [DIRECT] button to select that station.
 - * Press and hold one of the [DIRECT] buttons for 2 seconds or longer to store the current station into the preset memory.

● Using the [DIRECT] key.

1. Press the [LIST] button or touch the screen when the STANDARD screen is displayed, then touch the [P.CH SELECT] key.
2. Touch the corresponding [DIRECT] key to recall the stored station.
 - * You can select the desired band to touch the [BAND] key.
3. Touch the [RTN] key or press the [LIST] button to return to the previous mode.

Manual memory

1. Select the desired station with seek tuning, manual tuning or preset tuning.
2. Press and hold one of the **[DIRECT]** buttons for 2 seconds or longer to store the current station to that preset memory.

Auto store

Auto store selects 6 TV stations automatically and stores each one into a preset memory.

If there are not 6 stations with good reception, stations previously stored in memory remain and only the strong stations are stored into memory.

1. Press the **[BAND]** button and select the desired TV band. (TV1 or TV2)
2. Touch the screen or press the **[LIST]** button, the MENU screen appears.
3. Touch the **[SUB MODE]** key in the MENU screen, the **[AUTO STORE]** key appears in the display.

Touch and hold the **[AUTO STORE]** key for 2 seconds or longer. The stations with good reception are stored automatically to the preset channels.

Preset scan

Preset scan allows the user to view each preset position before it automatically advances to the next preset. This function is useful for searching for desired TV station in memory.

1. Touch the screen or press the **[LIST]** button, the MENU screen appears.
2. Touch the **[SUB MODE]** key in the MENU screen, the **[PRESET SCAN]** key appears in the display.

Touch the **[PRESET SCAN]** key to start preset scan. The unit starts scanning each station for 7 seconds sequentially.

3. When the desired channel is received, touch the **[PRESET SCAN]** key again.

Setting the TV diver

* This function is enabled only when the panel is open.

* Normally use the TV diver with the "ON" position.

You can change the reception setting for the TV antenna connected to the TV tuner.

1. Press the **[ADJ]** button to switch to the ADJUST MODE menu.

2. Touch the **[TV]** key to select "TV DIVER".
Touch the **[TV DIVER]** key to display **[ON]/[OFF]** key.
3. Touch the **[ON]** key or **[OFF]** key to set the selected reception setting.
 - **ON:**
Sets reception emphasizing the visual.
 - **OFF:**
Sets the diver setting to OFF.
4. Press the **[ADJ]** button or touch the **[RTN]** key to return to the previous mode.

Sirius operation

What is Sirius Satellite Radio?



Sirius is radio the way it was meant to be: Up to 100 new channels of digital quality programming delivered to listeners coast to coast via satellite. That means 50 channels of completely commercial-free music. Plus up to 50 more channels of news, sports, and entertainment from names like CNBC, Discovery, SCI-FI Channel, A&E, House of Blues, E!, NPR, Speedvision and ESPN.

Sirius is live, dynamic entertainment, completely focused on listeners. Every minute of every day of every week will be different. All 50 commercial-free music channels are created in-house and hosted by DJs who know and love the music. Do you like Reggae? How about Classic Rock or New Rock? Sirius has an array of choices spanning a vast range of musical tastes including the hits of the 50's, 60's, 70's, & 80's as well as Jazz, Country, Blues, Pop, Rap, R&B, Bluegrass, Alternative, Classical, Heavy Metal, Dance and many others...

From its state-of-the-art, digital broadcasting facility in Rockefeller Center, New York City, Sirius will deliver the broadest, deepest mix of radio entertainment from coast to coast.

Sirius will bring you music and entertainment programming that is simply not available on traditional radio in any market across the country. It's radio like you've never heard before.

So Get Sirius and Listen Up! For more information, visit siriusradio.com.

Selecting Sirius Radio modes

Press the [FUNC] button to select the Sirius mode.

The Sirius indication lights entering the mode that was engaged when the unit was turned off last time.

Selecting a band

Press the [BAND] button to select a band.

Each press of the button changes the display as shown below.

SR1 → SR2 → SR3 → SR1 ...

● Information displayed during reception

The following information is displayed when Sirius Radio cannot be received normally.

- **UPDATING** : when the receiver is turned on the first time or after a reset
- **ACQUIRING** : when a channel is being tuned in (no signal is yet received)
- **INVALID CH** : a channel without a broadcast has been selected
- **NO SIGN-UP** : a channel not covered by your contract

Switching displayed channel labels

● Panel closed

1. Press the [DISP] button to show the sub display.
2. Hold down the [DISP] button for 1 second to sequence the displayed channel labels as shown below.

CH.NAME → TITLE → ARTIST → CATEGORY → RADIO TEXT → CH. NAME...

● Panel open

1. Press the [DISP] button to display TITLE INDEX. CH.NAME, TITLE, ARTIST and CATEGORY appear.
2. Touch the key whose label you wish to display ([CH.NAME], [TITLE], [ARTIST] or [CATEGORY]).
3. Press the [DISP] button to return to the previous mode.

Displaying radio text

* Radio text is only displayed for stations that transmit such information.

Touch the screen in the STANDARD screen to display radio text.

Selecting stations with the KEY PAD

* This function displays the KEY PAD on the screen enabling you to tune in through auto store, preset scan or by entering a frequency.

Press the [KEY PAD] button to display the KEY PAD.

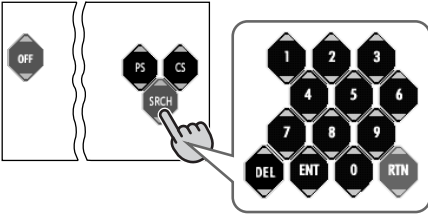

● Selecting channels

1. Touch the [SRCH] key to switch the KEY PAD.
2. Touch the [0]–[9] key corresponding with the frequency you desired. When you touch the wrong number ([0]–[9] key), you can cancel that to touch the [DEL] key.
3. Touch the [ENT] key. The radio channel you required would be tuned.

● To perform a preset scan,

touch the [PS] key.

● To perform a category scan,

touch the [CS] key.

● To cancel the KEY PAD display,

press the [KEY PAD] button, or touch the [OFF] key.

Channel selection

Channels are selected with the following buttons.

- The [◀] or [▶] button
- A [DIRECT] button

* For details, see the following operation descriptions.

Notes:

* The audio output is muted and other button operations are not accepted during channel selection.

Tuning mode (T-MODE)

There are two channel selection modes: seek mode and manual mode.

● Seek tuning

Only channels that can be received are selected while channels without broadcasts and channels not covered by the contract are automatically skipped.

1. Press the [◀] or [▶] button.
The receiver seeks the next available channel below or above the current channel.
2. Press and hold the [◀] or [▶] button.
The receiver moves to seek channels below or above the current channel. If the channel found when either button is released is available, that channel is received. Otherwise, seeking continues until an available channel is found.

● Manual tuning

Any channel including channels without broadcasts and channels not covered by the contract can be selected during manual tuning.

1. Press and hold the [BAND] button for 1 second or longer.
* This changes the seek mode to manual mode and the "MANU" indicator on the display lights. When this operation is performed in manual mode, the seek mode is engaged and the "MANU" indicator on the display goes off.

Notes:

- The receiver automatically reverts to the seek mode when the [◀] or [▶] button is not used for 7 seconds in the manual mode.
2. Press the [◀] or [▶] button. The receiver moves to channels above or below the current channel one by one.
 3. Press and hold the [◀] or [▶] for 1 second or longer.
The receiver moves to seek channels below or above the current channel and the channel found when either button is released is received.

Recalling a preset station

A total of 18 SIRIUS stations can be stored (6-SR1, 6-SR2 and 6-SR3). This allows you to select your favorite SIRIUS stations and store them in memory for later recall.

● Using the [DIRECT] key

1. Press the [LIST] button.
2. Press the [BAND] button or touch the [BAND] key to select the desired band.

Sirius operation

3. Touch the [DIRECT] key (1 to 6) to select the desired preset station.
4. Touch the [RTN] key to return to the previous mode.

● Using the [DIRECT] button

1. Press the [BAND] button and select the desired SIRIUS band (SR1, SR2 or SR3).
2. To recall a stored SIRIUS station, press the desired [DIRECT] button to select that station.
 - * Press and hold one of the [DIRECT] buttons for 2 seconds or longer to store the current station into preset memory.

Manual memory

1. Select the desired station with seek tuning, manual tuning or preset tuning.
2. Press and hold one of [DIRECT] buttons for 2 seconds or longer to store the current station into preset memory.

Notes:

- When the name of a channel stored in memory is changed by a broadcasting station, the display may show a channel name that differs from the stored name.
- A channel stored in memory may be discontinued at the option of the broadcasting station.

Category selection function

SIRIUS Radio allows you to select broadcast channel category (contents).

Receiving stations selected by category

1. Touch the screen in the STANDARD screen.
2. Touch the [CAT SELECT].

● Selecting from preset categories

- 2-1. Touch the [PRESET] key and select a category by touching a [DIRECT] key (1 to 6) storing the desired category.

● Selecting by displaying all categories

- 2-1. Touch the [ITEM SELECT] key to display a category.
- 2-2. Touch the [↓] or [↑] on the screen to select the desired category on the screen.
- 2-3. Select by touching a [DIRECT] key (1 to 6).
3. Press the [◀] or [▶] button to tune in a station. This starts seek tuning and broadcast channels that meet the specified category are selected.

Notes:

- When the category selection mode is entered, the category of the last received channel is displayed first.
- The category selection mode is canceled when no channel with the selected category can be found.
- Press the [◀] or [▶] button within 7 seconds after a channel has been set to continue seeking channels up or down. The category selection mode is canceled and normal reception is resumed if no operation is performed for 7 seconds.

Presetting a category

A category can be preset by registering specific categories in [DIRECT] keys 1 to 6. Then the desired category can be recalled by pressing the corresponding [DIRECT] keys.

1. Touch the screen in the STANDARD screen.
2. Touch [CAT SELECT] to open the ITEM SELECT screen.
3. Touch the [ITEM SELECT] key to display a category.
4. Touch the [↓] or [↑] on the screen to select the desired category on the screen.
5. Touch the category you wish to store in memory.
6. Touch the [PRESET] key to open the preset screen.
7. Touch and hold down for 2 seconds or longer the Preset No. key you wish to store in memory.

Notes:

- When the name of a channel stored in memory is changed by a broadcasting station, the display may show a channel name that differs from the stored name.
- A channel stored in memory may be discontinued at the option of the broadcasting station.

Scan function

There are two scan modes: a category scan mode and a preset scan mode.

During scanning channels are displayed in abbreviated form and the display mode cannot be switched.

● Category scanning

In a category scan, broadcast channels in the same category as the current channel are selected about every 10 seconds.

1. Touch the screen in the STANDARD screen.
2. Touch **[SUB MODE]** to open the SUB MODE screen.
3. Touch the **[CATEGORY SCAN]** key.

Note:

- Category scanning is not available when no category is defined for the current channel.

● Preset scan

A preset scan scans the channels (up to 18 channels) stored in the preset memory about every 10 seconds.

1. Touch the screen in the STANDARD screen.
2. Touch **[SUB MODE]** to open the SUB MODE screen.
3. Touch the **[PRESET SCAN]** key.

Other Functions

Always turning on the button illumination on the operation panel

Note:

- The following operation is enabled when the panel is open.
- Doing this operation turns on and off the illumination only for the buttons of VoL **[+]** and **[-]**, **[DISP]**, and **[OPEN]**.

The button illumination on the operation panel when the display is turned upward, can be switched between "ON" and "OFF".

The factory default setting is ON.

- "OFF": Button illumination on the operation panel turns on for 5 seconds;
 - "ON": Button illumination is always on when the power is turned on;
1. When the panel is open, press the **[ADJ]** button to show the ADJUST MODE menu.
 2. Touch the **[↓]** key to select "UPPER ILLUMI".
 3. Touch the **[UPPER ILLUMI]** key to select "ON" or "OFF".
 4. Touch the **[ON]** or **[OFF]** key for setting.
 5. Press the **[ADJ]** button or touch the **[RTN]** key to return to the previous mode.

* To set "ON" again, switch "OFF" to "ON" manually.

Entering titles

Titles up to 10 characters long can be stored in memory and displayed for Radio stations, TV stations and CD changer. The numbers of titles that can be entered for each mode are as follows.

Mode	Number of titles
TUNER mode	30 titles
TV mode	15 titles

CD changer mode	Number of titles
CDC655z connected	60 titles
CDC655Tz connected	100 titles
CDC1255z connected	50 titles
DCZ625 connected	100 titles

* You cannot enter titles with the unit in Seek, Preset Scan, Auto store (TUNER or TV) mode. Cancel each of those operations before entering titles.

1. Press the **[FUNC]** button to select the mode you want to enter a title (TUNER, CD changer or TV).
2. Select and play a CD in the CD changer or tune in to a Radio station or a TV station for which you want to enter the title.
3. Touch the screen or press the **[LIST]** button, the MENU screen appears.

Other Functions

4. Touch the [TITLE INPUT] key in the MENU screen.
The title input mode display appears.
5. Touch the characters, symbols, etc. shown in the display to input titles.
 - “←→” : Centering
 - “BS” : Backspace
 - “□” : Space
 - “MEMO” : Memory
 - “▼(▲)” : Scroll

NOTE:

- Up to 10 characters can be input.
 - To switch the character types, touch the scroll key (▼) at the lower left of the display.
6. Repeat the step 4 to enter the complete title.
 7. Touch the [MEMO] key for 2 seconds or longer to store the title into memory and cancel title input mode.

Title list play

You can display a list of titles, then select the disc or broadcast station to listen to from that list.

- * You can not display a title list with the unit in Seek, Preset Scan, Auto store (Tuner or TV) mode. Cancel those operation modes before to display a title list.
1. With the unit in radio, CD/MD changer or TV mode, touch the [P. CH SELECT], [DISC SELECT] key. A title list is displayed. The following functions can be carried out in a title list display.
 - **TUNER:** A title of a station stored in the presets 1 to 6 or frequency is displayed;
 - **CD/MD changer:** DISC titles for discs 1 to 6 are displayed (By changing over a display page in case of 12-CD changer, disc 7 to 12 can be displayed). When there is not any disc in a changer, "NO DISC" is displayed.
 - **TV/SIRIUS:** A title of a channel stored in the presets 1 to 6 or a channel number is displayed.
 2. Touch the [DIRECT] key (1 to 6) to select one of the items 1 to 6 and reproduce the selected broadcast station or disc.
 - * In case of 12-CD changer, touch the [DISC SELECT] key to change over to a list display of discs 7 to 12.
 3. Touch the [RTN] key again to return to the previous mode.

Setting the auto dimmer

The brightness of the color LCD display is adjusted automatically in proportion to the surrounding light. The auto dimmer function can switch between ON and OFF.

ON : Auto dimmer function is set.

OFF : Auto dimmer function is cancelled.

* The factory default setting is "ON".

1. Press the [ADJ] button to display the ADJUST MODE menu.
2. Touch the [AUTO DIMMER] key to select "ON" or "OFF".
3. Touch the "ON" or "OFF" key for setting.
4. Press the [ADJ] button or touch the [RTN] key to return to the previous mode.

Adjusting the dimmer level

You can adjust the reduced illumination level of the dimmer. When driving at night with the inside of the car, the auto dimmer function can reduce the display illumination linked "to the illumination power supply of the car" in this unit in order to prevent glare from the display.

* This function is enabled only when the auto dimmer function is set up to "OFF".

● The factory default:

When the car light is off: Brightest setting

When the car light is on: Medium brightness

1. When the panel is open, press the [ADJ] button to display the ADJUST MODE menu.
2. Touch the [DIMMER LEVEL] key to adjust the dimmer level.
3. Touch the [+] or [-] key to adjust.
4. Press the [ADJ] button again or touch the [RTN] key two times.
The unit returns to the previous mode.

Setting the button illumination

* The factory default setting is "GREEN" (green).

1. When the panel is open, press the [ADJ] button to select the ADJUST MODE menu.
2. Touch the [] key to select "KEY ILLUMI".
3. Touch the [KEY ILLUMI] key to select "RED" (red) or "GREEN" (green).
4. Touch the [RED] or [GREEN] key to select a desired mode and set it.
5. Press the [ADJ] button again or touch the [RTN] key. The unit returns to the previous mode.

Setting the beep

- * The sound heard when you make operations is called “beep”. The unit can be set up so that it does not produce this beep sound.
 - * The factory default is “BEEP ON”.
1. When the panel is open, press the [ADJ] button to select the ADJUST MODE menu.
 2. Touch the [↓] key to select “BEEP”.
Touch the [BEEP] key to select “ON” and “OFF”.
 3. Touch the [ON] or [OFF] key to select a desired mode and set it.
 4. Press the [ADJ] button again or touch the [RTN] key. The unit returns to the previous mode.

3. Touch the [VISUAL AUX SENS] key to select “HIGH”(HIGH) or “MID”(mid) or “LOW”(low).
4. Touch the “HIGH” or “MID” or “LOW” key to select desired mode and set it.
5. Press the [ADJ] button or touch the [RTN] key to return to the previous mode.

Triggered audio mute for cellular telephones

This unit requires special wiring to mute the audio signal automatically when a cellular telephone rings in the car.

- * This function is not compatible with all cellular telephones. Contact your local authorized Clarion dealer for information on proper installation and compatibility.

Setting the motion and sprite pattern speed

- * The factory default setting is “HIGH” (high).
1. When the panel is open, press the [ADJ] button to select the ADJUST MODE menu.
 2. Touch the [MOTION SENS] key to select “HIGH” (high) or “MID” (mid) or “LOW” (low).
 3. Touch the “HIGH” (high) or “MID” (mid) or “LOW” (low) key to select a desired mode and set it.
 4. Press the [ADJ] button again or touch the [RTN] key. The unit returns to the previous mode.

Clock Adjustment

1. When the panel is open, press the [ADJ] button to select the ADJUST MODE menu.
2. Touch the [↓] key to select “CLOCK”.
Touch the [CLOCK] key to adjust the time.
3. Touch the [▲],[▼],[a.m] or [p.m] key to adjust the time.
* The time is displayed in 12-hour format.
4. Press the [ADJ] button again or touch the [RTN] key two times. The unit returns to the previous mode.

Setting the visual input sound level

You can adjust an input sound level of visual1/2.

- * The factory default setting is “HIGH”(high).
1. Press the [ADJ] button to display the ADJUST MODE menu.
 2. Touch the [↓] key to select “VISUAL AUX SENS”.

5.1 ch Surround Decoder Operations

5.1 ch Surround Decoder control function

This function is available when a 5.1 ch Surround Decoder (DVH920) is connected.

When the 5.1 ch Surround Decoder (DVH920, sold separately) is CeNET connected, the 5.1 ch Surround Decoder Control unit (DVC920, sold separately) cannot be used.

This section describes operation procedures only. For other details, refer to the owner's manual supplied with the 5.1 ch Surround Decoder.

* For details on functions of each mode, refer to the owner's manual supplied with the DVH920.

1. Press the **[ADJ]** button to show the ADJUST MODE menu.
2. Touch the **[SOUND]** key.

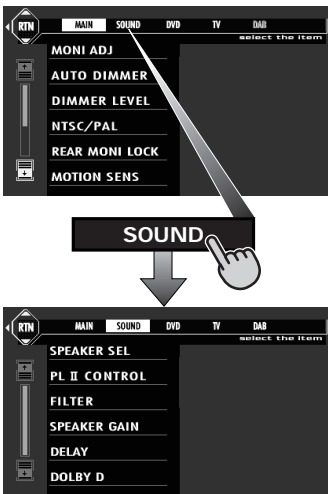

3. Touch the required keys to make the desired setting.

● SPEAKER SEL (speaker sel)

This function determines center speaker, surround speaker and sub woofer connection.

- 3-1. Touch the **[SPEAKER SEL]** key to show the submenu.
- 3-2. Touch the **[CENTER SP]**, **[SURROUND SP]** or **[SUB WOOFER]** key and the "ON" or "OFF" key to turn speakers on or off depending on what speakers are connected.
 - The default value is "ON".
 - The phase of the "SUB WOOFER" is reversed in the ON- setting. The default value is "ON+".

● PL II CONTROL

* This function is available only when the MUSIC MODE is selected for Dolby PL II. For setup details, see "Selecting the Dolby PL II (Dolby Pro Logic II) type."

- 3-1. Touch the **[PL II CONTROL]** key to show the submenu.
- 3-2. Touch the **[PANORAMA]**, **[DIMENSION]** or **[CENTER WIDTH]** key to select respective item.

[PANORAMA]:

Touch the **[ON]** or **[OFF]** key. "OFF" is the default value.

[DIMENSION]:

Touch the **[▲]** or **[▼]** key to make adjustments between 0 and 6. The default value is "3".

[CENTER WIDTH]:

Touch the **[▲]** or **[▼]** key to make adjustments between 0 and 7. The default value is "3".

● FILTER

This function is used to select filter frequencies that suit the speakers that are used.

* This function is not available for speakers whose SPEAKER SEL setting is set to OFF.

- 3-1. Touch the **[FILTER]** key to show the submenu.
- 3-2. Touch the **[FRONT HPF]**, **[CENTER HPF]**, **[SURROUND HPF]** or **[SUB WOOFER LPF]** key to set respective item.
- 3-3. Touch **[▲]** or **[▼]** key to make settings.

[FRONT HPF]:

This function can be set to the following four settings: 50 Hz, 80 Hz, 120 Hz or THROUGH. "THROUGH" is the default value.

[CENTER HPF]:

This function can be set to the following three settings: 50 Hz, 80 Hz and 120 Hz. "120 Hz" is the default value.

[SURROUND HPF]:

This function can be set to the following four settings: 50 Hz, 80 Hz, 120 Hz or THROUGH. "THROUGH" is the default value.

[SUB WOOFER LPF]:

This function can be set to the following three settings: 50 Hz, 80 Hz and 120 Hz. "120 Hz" is the default value.

5.1 ch Surround Decoder Operations

● SPEAKER GAIN

This function sets speaker output level.

* This function is not available for speakers whose **SPEAKER SEL** setting is set to OFF.

- 3-1. Touch the **[SPEAKER GAIN]** key to show the submenu.
- 3-2. Touch the **[FRONT L]**, **[CENTER]**, **[FRONT R]**, **[SURROUND R]**, **[SURROUND L]** or **[SUB WOOFER]** key to set respective item.
- 3-3. Touch the **[▲]** or **[▼]** key to make adjustments in the range -10 dB to +10 dB in 1 dB step increments. The default value is **"0 dB"**.

● DELAY

This function adjusts the timing of the speakers so that they are synchronized with front speaker output.

* This function is not available for speakers whose **"SPEAKER SEL"** setting is set to OFF.

- 3-1. Touch the **[DELAY]** key to show the submenu.
- 3-2. Touch the **[CENTER SP]** or **[SURROUND SP]** key to set respective item.
- 3-3. Touch the **[▲]** or **[▼]** key to adjust.

[CENTER SP]:
Adjustments are made in the range 0 ms to 5 ms. The default value is **"0 ms"**.

[SURROUND SP]:
Adjustments are made in the range 0 ms to 15 ms. The default value is **"0 ms"**.

● DOLBY D

This function sets the dynamic range compression.

* This function is not available for speakers whose **"SPEAKER SEL"** setting is set to OFF.

- 3-1. Touch the **[DOLBY D]** key to show the submenu.
- 3-2. Touch the **[MAX]**, **[STD]** or **[MIN]** key to select respective item.

*The default value is **[MAX]**.
4. When all settings are completed, press the **[ADJ]** button or touch the **[RTN]** key to return to the previous mode.

Output adjustment of subwoofer volume, center volume and balance/fader

1. Press the **[A-M]** button and touch the **[DETAIL]** key.

2. To make an adjustment on :

● Subwoofer volume adjustment

- 2-1. Touch the **[SUBWOOFER VOL]** key, then touch the **[▲]** or **[▼]** key to adjust to desirable level.

* The factory default setting is **"0"**. (Setting range : -6 to 3)

● Center volume adjustment

- 2-1. Touch the **[CENTER VOL]** key, then touch the **[▲]** or **[▼]** key to adjust to desirable level.

* The factory default is **"0"**. (Setting range : -6 to 0)

● Balance/Fader adjustment

- 2-1. Touch the **[BAL/FAD]** key.

Touch the **[▲]** or **[▼]** key to adjust the balance level.

[▲] key : emphasized the sound from the front speakers.

[▼] key : emphasized the sound from the rear speakers.
- 2-2. Touch the **[◀]** or **[▶]** key to adjust the fader level.

[◀] key : emphasized the sound from the left speakers.

[▶] key : emphasized the sound from the right speakers.
3. When the adjustment is complete, touch the **[RTN]** key or press the **[A-M]** button to return to the STANDARD screen.

5.1 ch Surround Decoder Operations

DSF mode

DSF effect ON/OFF

* The factory default setting is "OFF".

1. Press the [A-M] button.
2. Touch the [STATUS] key.
3. Touch the [DSF] key to select "on" and "off".
4. Each time the [ON/OFF] key is touched, the on and off statuses are switched alternately.
5. After the setting, press the [A-M] button again or touch the [RTN] key to return to the STANDARD screen.

Note:

- If the DSF effect is set to OFF, the adjustment made in "DSF" is not reflected in the music source.

Selecting the DSF type

1. Press the [A-M] button and touch the [DSF] key.
2. Touch the key for the desirable type to select it.
3. When the setting is finished, touch the [RTN] key or press the [A-M] button to return to the previous mode.

P.EQ mode

P.EQ effect ON/OFF

* The factory default setting is "OFF".

1. Press the [A-M] button.
2. Touch the [STATUS] key.
3. Touch the [P.EQ] key to select "on" and "off".
4. Each time the [ON/OFF] key is touched, the on and off statuses are switched alternately.
5. After the setting, press the [A-M] button again or touch the [RTN] key to return to the STANDARD screen.

Note:

- If the P.EQ effect is set to OFF, the adjustment made in "P.EQ" is not reflected in the music source.

Setting and storing P.EQ Properties

1. Press the [A-M] button to show the AUDIO MODE menu.
2. Touch the [P.EQ] key to show the P.EQ adjusting display.
3. Touch the key for the desirable type to select it.
The P.EQ adjustment contents are as follows:

● SIGNAL

* The factory default setting is "P.NOISE".

This function selects [P. NOISE] or [MUSIC].

● SPEAKER SELECT

* The factory default setting is "FRONT".

This function selects [FRONT], [CENTER] or [SURROUND].

● "BAND"

* The factory default setting is "BAND1".

Select the channel to be compensated (BAND1, BAND2, BAND3).

● "FREQUENCY"

* The factory default setting is "1 kHz".

Select the center frequency that you want to compensate from the range of 20 Hz to 20 kHz. (1/3 octave step, 31 points)

● "Q"

* The factory default setting is "1".

Set the sharpness of the Q-curve to one of the parameters: 1, 3, 5, 7 and 20.

● "GAIN"

* The factory default setting is "0".

Adjust the gain (output level) in the range of -12 dB to +12 dB. (1 dB step, 25 points)

4. After making adjustments to a desired pattern by repeating the operations of item3, touch the [RNT] key or press the [A-M] button to return to the previous mode.

Selecting the Dolby PLII (Dolby Pro Logic II) type

1. Press the [A-M] button and touch the [Dolby PLII] key.
2. Touch the key for the desirable type to select it.
3. When the setting is finished, touch the [RTN] key or press the [A-M] button to return to the previous mode.
* The factory default is "off".

12. IN CASE OF DIFFICULTY

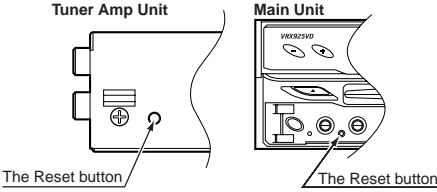
	Problem	Cause	Measure
GENERAL	Power does not turn on. (No sound is produced.)	Fuse is blown.	Replace with a fuse of the same amperage. If the fuse blows again, consult your store of purchase.
		Incorrect wiring.	Consult your store of purchase.
	Nothing happens when buttons are pressed. Display is not accurate.	The microprocessor has malfunctioned due to noise, etc.	Turn off the power, then press the [RELEASE] lever and remove the DCP. Press the reset button both of tuner amp unit and main unit for about 2 seconds with a thin rod. Note: When the reset button is pressed, turn off the ACC power. 
The remote controller does not work.	Direct rays of the sun fall on the light-receptive part of the remote controller.	When direct rays of the sun fall on the light-receptive part of the remote controller, it may not work.	
	The batteries of the remote controller unit are dead or there is no battery in the remote controller unit.	Check the batteries of the remote controller unit.	
DVD Player	Disc cannot be loaded.	Another disc is already loaded.	Eject the disc before loading the new one.
		There is a foreign matter already in place.	Eject the foreign matter forcibly.
	Sound skips or is noisy.	Compact disc is dirty.	Clean the compact disc with a soft cloth.
		Compact disc is heavily scratched or warped.	Replace with a compact disc with no scratches.
	Sound is bad directly after power is turned on.	Water droplets may form on the internal lens when the car is parked in a humid place.	Let dry for about 1 hour with the power on.
Disc cannot play with the display "PARENTAL VIOLATION" shown.	The view is limited.	Release the view limitation or change the parental level. See the subsection "Setting up the parental level".	

	Problem	Cause	Measure
TV	The image is not displayed.	The parking brake is not pulled.	Check that the parking brake is applied.
	The display is dark.	The brightness control is too low.	Adjust the brightness properly.
		The operating condition is not good.	The temperature inside the vehicle may be 0°C or less. Set to an appropriate temperature (25°C or so) and check it again.
		The headlight of the vehicle is lit.	The display is made dark at night to prevent the glare (When the headlight of the vehicle is lit in the daytime, the display gets dark).
	The color of the display is light or a shade of color is not good.	The color is not adjusted adequately.	Check that COL and HUE are adjusted properly.
	When the VTR is connected, the image is disturbed.	Improper NTSC/PAL setting	Set the NTSC/PAL properly according to the VTR.
	When the TV tuner is connected, the image gets unclear.	Bad receiving condition	A radio wave may not reach sufficiently due to obstruction of mountains or buildings. Check it again at a place where a radio wave can be received properly.
	The TV tuner has a double or triple image.	Bad receiving condition	It may be under the influence of radio wave reflected by mountains or buildings. Check it again after changing place or direction.
The TV tuner has spots or stripes in the image.	Presence of jamming	It may be under the influence from automobiles, streetcar, power cable, neon sign, and so forth. Check it again after changing place.	
There are red, green, and blue points in the display.	_____	This is not a failure, but a phenomenon peculiar to a liquid crystal panel (The LCD panel is produced according to technology with very high precision. Note that, though there are effective pixels of 99.99% or more, pixel missing or normally lit pixels account for 0.01%).	

13. ERROR DISPLAYS

If an error occurs, one of the following displays is displayed.

Take the measures described below to eliminate the problem.

		Cause	Measure
DVD PLAYER	ERROR 2	A CD is caught inside the CD deck and is not ejected.	This is a failure of CD deck's mechanism and consult your store of purchase.
	ERROR 3	A CD cannot be played due to scratches, etc.	Replace with a non-scratched, non-warped-disc.
	ERROR 6	A CD is loaded upside-down inside the CD deck and does not play.	Eject the disc then reload it properly.
CD CHANGER	ERROR 2	A CD inside the CD changer is not loaded.	This is a failure of CD changer's mechanism and consult your store of purchase.
	ERROR 3	A CD inside the CD changer cannot be played due to scratches, etc.	Replace with a non-scratched, non-warped-disc.
	ERROR 6	A CD inside the CD changer cannot be played because it is loaded upside-down.	Eject the disc then reload it properly.
MD CHANGER	ERROR H	Displayed when the temperature in the MD changer is too high and playback has been stopped automatically.	Lower the surrounding temperature and wait for a while to cool off MD changer.
	ERROR 2	An MD inside the MD changer is not loaded.	This is a failure of MD changer's mechanism and consult your store of purchase.
	ERROR 3	An MD inside the MD changer cannot be played due to scratches, etc.	Replace with a non-scratched, non-warped-disc.
	ERROR 6	An MD inside the MD changer cannot be played because it is loaded upside-down.	Eject the disc then reload it properly.
Displayed when a non-recorded MD is loaded in the MD changer.		Load a pre-recorded MD in the MD changer.	

For the DVD changer, refer to the Owner's Manual provided with the DVD changer.

If an error display other than the ones described above appears, press the RESET button. If the problem persists, turn off the power and consult your store of purchase.

* When the reset button is pressed, frequencies of TV/radio stations, titles, etc. stored in memory are cleared.

14. SPECIFICATIONS

FM Tuner

Frequency Range: 87.9 MHz to 107.9 MHz
 Usable Sensitivity: 9 dBf
 50dB Quieting Sensitivity: 15 dBf
 Alternate Channel Selectivity: 70 dB
 Stereo Separation(1 kHz): 35 dB
 Frequency Response(+/-3 dB): 30 Hz to 15 kHz

AM Tuner

Frequency Range: 530 kHz to 1710 kHz
 Usable Sensitivity: 25 μ V

DVD player

System:
 Digital Versatile Disc System with CDDA capable

Usable discs: DVD video disc, Compact disc

Frequency Response:
 20Hz to 22 kHz (48 kHz) (± 1 dB)
 20Hz to 20 kHz (CD) (± 1 dB)

Signal to Noise Ratio: 100 dB (1 kHz) IHF-A

Dynamic Range: 100 dB (1 kHz)

Distortion: 0.01%

Audio Amplifier

Rated power output:
 18 W \times 4 (20 Hz to 20 kHz, 1%, 4 Ω)

Maximum power output:
 212 W (53 W \times 4)

Speaker impedance: 4 Ω (4 to 8 Ω)

Input

Audio input:
 130 \pm 60mVrms (High)
 600 \pm 80mVrms (Mid)
 840 \pm 100mVrms (Low)
 (input impedance 10k Ω or greater)

Video input:
 1.0 \pm 0.2 Vp-p (input impedance 75 Ω)

Video output

Video output:
 1.0 \pm 0.2 Vp-p (output impedance 75 Ω)

LCD Monitor

Screen Size: 7-inch wide type
 6" Width (152 mm) \times 3-5/16" Height (85 mm)

Display method:
 Transmission type TN liquid crystal display

Drive method: TFT (thin-film transistor)
 active matrix driving

Pixels: 336,960 (1440 \times 234)

General

Power source voltage:
 14.4 V DC (10.8 to 15.6 V allowable)
 Ground: Negative
 Current consumption: 4.0 A (1 W)
 Auto Antenna Rated Current: 500 mA less
 Dimensions of the Main Unit:
 7" Width (178 mm) \times 1-15/16" Height (50 mm) \times 6-1/2" Depth (165 mm)
 Dimensions of the Tuner Amp Unit:
 7" Width (178 mm) \times 1-1/2" Height (37.5 mm) \times 8-1/4" Depth (209.5 mm)
 Weight of the Main Unit: 2.3 kg
 Weight of the Tuner Amp Unit: 1.1kg
 Dimensions of the Remote Control Unit:
 2-1/8" Width (54 mm) \times 1-1/8" Height (28.8 mm) \times 6-1/8" Depth (155 mm)
 Weight of the Remote Control Unit:
 100g (including battery)

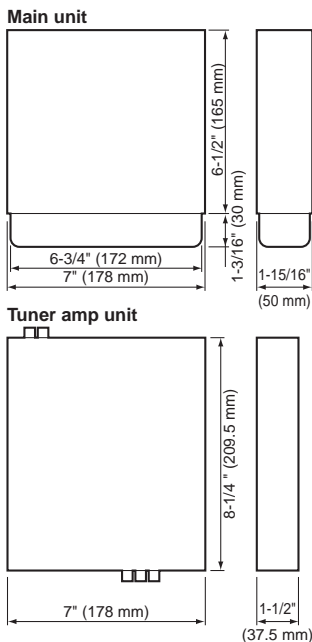

Notes:

- Specifications comply with JEITA Standards.
- Specifications and design are subject to change without notice for further improvement.